

COMPREHENSIVE GENERAL DEVELOPMENT CONTROL REGULATIONS - 2017

PART-III

PERFORMANCE REGULATION

(As modified up to October 2019)

Urban Development and Urban Housing Department

Block No.- 14, 9th Floor, New Sachivalaya, Gandhinagar - 382010. www.udd.gujarat.gov.in



Urban Development and Urban Housing Department, Block No.- 14, 9th Floor,
New Sachivalaya, Gandhinagar - 382010.
Website – www.udd.gujarat.gov.in



GOVERNMENT OF GUJARAT
URBAN DEVELOPMENT AND URBAN HOUSING DEPARTMENT
NOTIFICATION NO.GH/V/ 143 of 2019/EDB-102016-3629-L
SACHIVALAYA, GANDHINAGAR.

NOTIFICATION

Date:03.10.2019

NO.GH/V/ 143 of 2019/EDB-102016-3629-L: WHEREAS the Government of Gujarat is of the opinion that it is necessary, in the public interest, to make variations in the Comprehensive General Development Control Regulation-2017(CGDCR) notified vide Notification No.- GH/V/152 of 2018/ EDB - 102016 - 3629 - L, on dated 5th November 2018, (hereinafter referred as CGDCR) by the Urban Development and Urban Housing Department, Government of Gujarat, Gandhinagar.

WHEREAS, the Government of Gujarat published the said modifications under Government Notification, Urban Development and Urban Housing Department GH/V/5 of 2019/EDB-102016-3629-L, dtd.15.01.2019, in the Gujarat Government Gazette Ext. Part.IV-B dated.16.01.2019 on Page No.11-2 to 11-4 for inviting from any person, to submit suggestions or objections, if any with respect to the proposed modifications to the Principal Secretary to the Government of Gujarat, Urban Development and Urban Housing Department, Sachivalaya, Gandhinagar, in writing, within a period of two months from the date of publication of the said modifications in the Government Gazette.

AND WHEREAS, the Government of Gujarat has considered the suggestions and objections so received on merits;

NOW THEREFORE, in exercise of the power conferred by,

- (1) sub-section (2) of section 116A of the Gujarat Town Planning and Urban Development Act, 1976;
- (2) Section 155 of The Gujarat Municipalities Act, 1963;
- (3) Clause (a) of Section 31 the Gandhidham (Development and Control on Erection of Buildings) Act 1957; and
- (4) Section 54 of the Gujarat Industrial Development Act, 1962 (Guj. XXIII of 1962)

The Government of Gujarat hereby sanction the said variation with modification in the Comprehensive General Development Control Regulations-2017 as appended herewith.

It shall come into force from the date of this notification in the Official Gazette.

By order and in the name of the Governor of Gujarat,

(V. D. Vaghela)

Officer on Special Duty & Ex-Officio Joint Secretary
to the Government of Gujarat
Urban Development and Urban Housing Department

Copy to:

- ❖ PS to Hon'ble Governor of Gujarat.
- ❖ PS to Hon'ble Chief Minister of Gujarat.
- ❖ PS to Hon'ble Dy. Chief Minister of Gujarat.
- ❖ PS to Chief Secretary, Government of Gujarat.
- ❖ ACS to Urban Development and Urban Housing Department, Government of Gujarat.
- ❖ PS to all secretaries of all secretariats of Government of Gujarat.
- ❖ Principal Secretary, Industries and Mines Department, Gujarat.
- ❖ Principal Secretary, Panchayat and Rural Department, Gujarat.
- ❖ Vice Chairman and Managing Director, Gujarat Industrial Development Corporation, Gujarat.
- ❖ Municipal Commissioner, All Municipal Corporations.
- ❖ Chief Executive Authority, All Urban/Area Development Authorities.
- ❖ Commissionerate of Municipalities Administration, Gujarat State, Gandhinagar.(with request to circulate all Municipalities)
- ❖ Chief Town Planner, Gujarat State, Gandhinagar.
- ❖ Collector, All Districts
- ❖ District Development Officer, All District Offices.
- ❖ Manager, Government Central Press, Gandhinagar - With a request to publish the aforesaid notification in Part IV-B central Section, in the Gujarat Government Extra Ordinary Gazette of **Dated.03.10.2019** and forward 500 printed copies of the same to this department. The Gujarati version of the Notification will be forwarded shortly to you by the Legislative and Parliamentary Affairs Department, Sachivalaya, Gandhinagar.
- ❖ Legislative and Parliamentary Affairs Department, Sachivalaya, Gandhinagar - with request to send Gujarati version of the said Notification directly to the Manager, Government Central Press, Gandhinagar for its publication in the official gazette urgently.
- ❖ Director of Information, Gandhinagar- with request to issue suitable presses note.
- ❖ System Manager, Urban Development and Urban Housing Department, Gandhinagar- with request to publish in the department web site.
- ❖ The Select file of ' L ' Branch, U. D. & U. H. Dept.(2019)
- ❖ The personal file of Dy. Section Officer, L-Branch, U. D. & U. H. Dept.(2019)

CONTENTS

13. BUILDINGS AND INFRASTRUCTURE	1
13.1 Architectural Elements.....	1
13.1.1 Boundary Gate/ Compound Gate.....	1
13.1.2 Level of Building –Unit.....	1
13.1.3 Paving in building unit	1
13.1.4 Access Path.....	2
13.1.5 Plinth	3
13.1.6 Entrance	3
13.1.7 Minimum Clearance Height in Buildings	3
13.1.8 Mezzanine	4
13.1.9 Loft.....	4
13.1.10 Basement.....	4
13.1.11 Railings.....	5
13.1.12 Terrace.....	5
13.1.13 Staircases, corridors and Passageway	5
13.1.14 Ramp	6
13.2 Parking.....	10
13.2.1 Parking to be provided.....	10
13.2.2 Design of Parking for Cars	10
13.2.3 Design of Parking for Two-Wheelers	10
13.2.4 Design of Parking for Trucks.....	11
13.2.5 Specified Parking for loading and unloading	11
13.3 Lighting.....	11
13.4 Ventilation.....	11
13.4.1 Ventilation of Rooms.....	11
13.4.2 Ventilation of Basement.....	12
13.4.3 Ventilation of Atrium.....	12
13.4.4 Ventilation of Bathrooms and Water Closets.....	12
13.4.5 Ventilation of Staircase for Dwelling-1 & 2	12
13.4.6 Ventilation of Industrial Buildings	12
13.4.7 Ventilation of Special Buildings	12
13.4.8 Change of ventilation system	13
13.5 Heating and Air Conditioning	13
13.5.1 Air-Conditioning of Special Buildings.....	13
13.6 Water related Requirement	13
13.6.1 Water Storage Tank.....	13
13.6.2 Drinking Water Supply.....	13
13.7 Signage	13
13.8 Letter Box.....	14
13.9 Sanitation	14
13.9.1 For Residential Buildings	14
13.9.2 For All Buildings other than Residential	14
13.9.3 For Special Buildings.....	15
13.10 Drainage	15
13.10.1 Provision of Septic Tank, Seepage Pit and Soak Well	16
13.11 Electrical Infrastructure.....	17
13.12 Lifts and Elevators	17
13.12.1 For buildings exceeding 4mts height with following uses: Institutional, Assembly, Public Institutional, Educational-2	17
13.12.2 For buildings exceeding 10 mts height.....	17
13.12.3 General Requirements for Lifts and Elevators	18
13.13 External Façade	19

13.14	Display Structures	19
13.15	Occupant Load	19
14.	FIRE PREVENTION AND SAFETY	20
14.1	Requirement for Fire Safety Professionals in Buildings	20
14.1.1	Fire Officer	20
14.1.2	Fire Men	20
14.1.3	Applicability of Fire Safety Professionals.....	20
15.	SPECIAL BUILDINGS PERFORMANCE REGULATIONS.....	21
15.1	Visibility.....	21
15.2	Mixed Occupancy	21
15.3	Institutional Buildings.....	23
15.4	Public Safety	24
16.	STRUCTURAL SAFETY	25
16.1	Applicability	25
16.2	Structural Stability and Maintenance of Existing Buildings.....	25
16.3	Additions and Alterations to Existing Buildings.....	25
16.4	Change of Use of Buildings or Part of a Building.....	25
16.5	Structural Safety Provisions during Construction	25
16.6	Structural Safety Tests for Special Buildings	26
16.7	Design for Structural and Seismic Safety.....	27
16.7.1	Design Standards	27
16.7.2	Structural Inspection Report.....	28
16.8	Structural Safety of Display Structures.....	28
17.	ENVIRONMENTAL MANAGEMENT	29
17.1	Minimum Distance from Water body	29
17.2	Rain Water Management	29
17.2.1	Rain Water Disposal	29
17.2.2	Rain Water Harvesting.....	30
17.2.3	Rain Water Storage:.....	31
17.2.4	Solid Waste Bin for Residential Use.....	31
17.2.5	Solid Waste Bin for Non-Residential Use	31
17.3	Grey water Recycling.....	31
17.3.1	Applicability	31
17.3.2	Note: In every water closet or toilet it shall be mandatory to provide double button cistern (dual Flush tank) 32	
17.3.3	Provisions of Recycling System	32
17.3.4	Quality of Water and Treatment.....	33
17.3.5	General Provisions.....	33
17.3.6	Enforcement of Regulations	33
17.4	Tree Plantation	33
17.5	Solar Water Heating System	34
17.5.1	Roof Top Solar Energy Installations and Generation.....	34
17.6	Energy Efficient Buildings	35
17.7	Environment Impact Assessment.....	35
18.	POLLUTION CONTROL.....	36
18.1	Air Pollution.....	36
18.2	Water Pollution	36
18.3	Noise Pollution	36
18.4	Industrial Pollution	36
19.	MAINTENANCE AND UPGRADATION.....	37

19.1	Maintenance of Buildings.....	37
19.1.1	Responsibility for Maintenance of Buildings	37
19.1.2	Periodic Inspection and Maintenance Certificate	37
19.2	Maintenance of Lifts and Escalators	37
19.2.1	Responsibility for Maintenance of Lifts and Escalators	37
19.2.2	Maintenance Protocol	37
19.3	Maintenance of Fire Prevention and Safety Provisions	38
19.3.1	Periodic Inspection and Maintenance Certificate	38
20.	CONFORMITY TO OTHER ACTS AND REGULATIONS.....	39
20.1	Minimum Clearances from Trunk Infrastructure	39
20.1.1	Minimum Clearances from Electrical Lines	39
20.1.2	Minimum Clearances from Petroleum Pipelines.....	39
20.1.3	Minimum Clearances from Oil Well	39
20.1.4	Minimum Clearances from Water Body	39
20.2	No Objection Certificates (NOC)	40
20.2.1	NOC from Airport Authority	40
20.2.2	NOC from Railway	40
20.2.3	NOC from Commissioner of Police	40
20.2.4	NOC from Jail Authority.....	40
20.2.5	NOC from ISRO	40
20.2.6	NOC from ASI.....	40
20.2.7	NOC from Defence Establishment.....	40
20.2.8	Environmental Clearance	40
20.2.9	NOC under Urban Land Ceiling Act.....	40
20.3	Conformity to other Acts.....	41
20.3.1	Factories Act 1948 and Factories Rules under the Govt. of Gujarat	41
20.3.2	Gas Cylinders Rules 1981.....	41
20.3.3	Explosives Rules 1983 under Indian Explosives Act 1884.....	41
20.3.4	Manufacture, Storage and Import of Hazardous Chemicals Rules 1989.....	41
21.	Quality Control and Inspection.....	42
21.1	Applicability.....	42
21.2	Inspection and Safety Certificate:	42

TABLES

TABLE 13.1 BOUNDARY WALL/ COMPOUND WALL FOR ALL BUILDINGS(BW/CW)	1
TABLE 13.2 STAIRCASE DETAIL.....	5
TABLE 13.3 CORRIDORS AND PASSAGEWAY	6
TABLE 13.4 MINIMUM WIDTH OF RAMP AND RADIUS OF INNER CURVE BASED ON TYPE OF VEHICLES	7
TABLE 13.5 RAMP DETAILS BASED ON AREA OF PARKING IN BASEMENT	7
TABLE 13.6 RAMP FOR FIRE TENDER.....	8
TABLE 13.7 REQUIREMENT OF SANITATION	15
TABLE 13.8 OCCUPANT LOAD.....	19
TABLE 17.1 REUSE OF RECYCLED WATER	32
TABLE 17.2: BUILDING USE & BUILT-UP AREA	34
TABLE 17.3: NORMS FOR ROOF TOP SOLAR PV INSTALLATION AND GENERATION	34
TABLE 20.1: MINIMUM CLEARANCES FROM ELECTRIC LINES	39

13. BUILDINGS AND INFRASTRUCTURE

13.1 Architectural Elements

Table 13.1 Boundary Wall/ Compound Wall for all buildings(BW/CW)

Sr. No.	Use	Maximum BW/CW height from crown of the adjacent road (mt.)	
		Road Side	Other than adjacent road/ road side or all other side of building-unit
(1)	(2)	(3)	(4)
1	Other than Industrial	1.5	1.8
2	Industrial	3.0	3.0

1. For building-units at junction of roads, a grill fence shall be provided with the following provisions:

- At least 50% perforation in the grill.
- The base of the fence shall not exceed 0.8 mts from the level of the crown of the adjacent road for a length of 9 mts. from the corner of the building-unit at the junction.

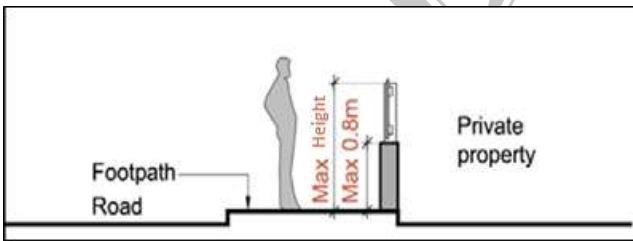

13.1.1 Boundary Gate/ Compound Gate

- Boundary gate shall not open outward and shall be provided with a means to prevent the gate from opening outward on the pavement or road.
- The minimum width of a boundary gate for all uses except Dwelling-1 & 2 shall be 6.0 mts.
- For building-units at junction of roads, the following shall be applicable:
 - A gate shall not be permitted on the curvature of the boundary wall.
 - If the adjacent road width is equal or more than 12.0 mts, the opening in the boundary wall shall be located at a minimum distance of 15.0 mts from the corner of the building-unit at the junction. If the length of the building-unit on the road side is less than 15.0 mts, the opening in the boundary wall shall be provided at the farthest end from the junction.

13.1.2 Level of Building –Unit

The level of the building shall be established with respect to the average ground level or high flood level, as may be applicable. This level shall in no case lower than the crown level of the adjacent road. For building-units with access from two or more roads, the level shall be considered from the wide road.

In the case of a building-unit where the level of the land is lower than the crown of the road in front and which in the opinion of the Competent Authority, could be drained off in the storm water drainage and sewer, the Competent Authority may permit a suitable lower level.

Any difference between the building-unit level and road level, shall be accommodated within the building-unit boundary.

13.1.3 Paving in building unit

Maximum of 50 % of the total open space including marginal open spaces and common plot of a building-unit shall be paved. The remaining shall be permeable for rain water percolation.

13.1.4 Access Path

1. Access path from the building-unit to the building entry or the plinth shall have a minimum width of 1.8mts with an even surface and devoid of steps.
2. In case of a sloping access path, the gradient shall not be greater than 1:12.
3. Any difference between the road level and building-unit level shall be accommodated within the building-unit boundary. Selection of floor material shall be made suitably to attract or to guide visually impaired persons (limited to coloured floor material) whose colour and brightness is conspicuously different from that of the surrounding floor material or the material that emits different sound to guide visually impaired persons; hereinafter referred as "guiding floor material". Finishes shall have a non-slip surface with a texture traversable by a wheel chair. Kerbs wherever provided should blend into a common level.

For all Buildings (Except Dwelling-1 & 2):

1. Minimum one entrance shall be provided that is accessible by people with disability and accompanied by appropriate signages as per Regulation 13.7
2. Minimum width of this ramped access path shall be 1.2 mts, 1.5mts and 1.8mts for the ramp length of 3.6 mts, up to 9mts and more than 9.0 mts respectively.
3. The pedestrian ramp leading main entrance required as per these regulations may be provided in the margin.
4. In case of sloping access path or ramp:

a. The gradient shall not be greater than 1:12.

b. Minimum width of ramp shall be 1.2mts and the maximum continuous length shall be 9mts. Such ramp shall have 800mm high hand rail on both sides extending 300 mm beyond top and bottom of the ramp. Minimum gap from the adjacent wall to the hand rail shall be 50mm.

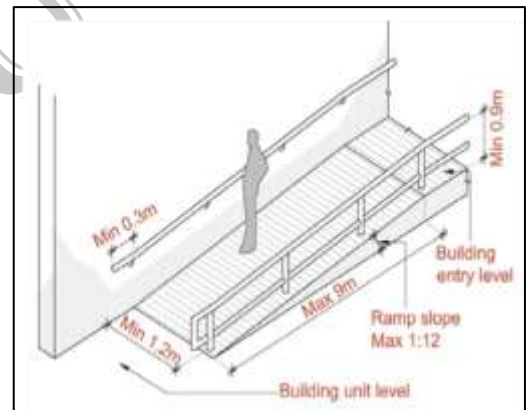

c. Entrance landing shall be provided adjacent to ramp, with the minimum dimension 1.2 mts x 1.5 mts.

d. The surface shall be adequately guide to visually impaired person by using colour and material guide brightness that is different from the surrounding floor material or by using 'guiding floor material' that emits different sounds.

e. Finishes shall have a non-slip surface with a texture traversable by a wheel chair.

f. Kerbs, wherever provided, should blend to a common level.

5. For any additional stepped approach:

a. Minimum width shall be 1.35 mts.

b. Size of tread shall not be less than 300 mm. and maximum riser shall be 150 mm.

c. The steps shall not have abrupt (square) nosing.

d. Maximum number of risers on a continuous flight without landing shall be limited to 12.

e. The stepped approach shall be provided with 900 mm, high hand rail on both sides. Hand rails shall extend 300 mm on the top and bottom flight of the steps.

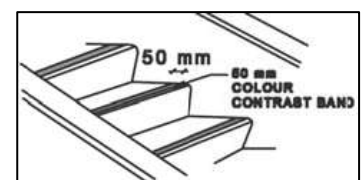
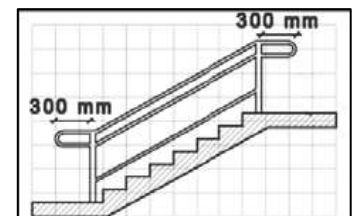

- f. All steps edges shall have a contrasting colour band of 50 mm width stretched entirely across the step width.
- g. The edges should also be non-slippery.

13.1.5 Plinth

1. The plinth of the habitable area of any building shall be at a minimum height of 0.45 mts from the established level of the building-unit.
2. The building may be permitted on hollow plinth at the ground level, with the following provisions:
Has maximum height of 3.5 mts from finished ground level to finished next floor level and minimum height shall be 3.0 mts from finished ground level to finished next floor level and is free of enclosures except for staircase and other permitted uses under these regulations.

13.1.6 Entrance

For all buildings other than Dwelling - 1 & 2, entrance with the following specifications shall be provided:

1. Minimum clear opening of the entrance door shall be 900 mm and shall not be provided with a step that obstructs the passage of a wheelchair user.
2. Level difference at threshold shall not exceed 12 mm.
3. Manual doors should incorporate kick plates 300 mm high to withstand impact of wheelchair footrest where doors are glazed.
4. Door handle and locks should be positioned between 900-1000 mm above floor level and must enable the user to operate it with a single hand.

13.1.7 Minimum Clearance Height in Buildings

1. For Dwelling Units or Commercial Buildings:
 - a. All habitable spaces shall have minimum height of 2.9 mts between finished floor levels.
 - b. All circulation and service spaces such as verandah, bathroom, washroom, toilet, passage, puja room, store room and stair cabin shall have a minimum clearance height of 2.1 mts.

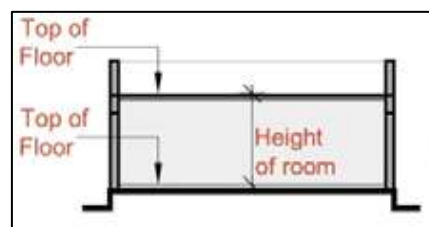

2. **For Industrial Uses**, all occupiable spaces shall have a minimum clearance height of 3.0 mts.

3. **In case of folded roof**, minimum clearance height shall be 3.0 mts (measured from the lowest point of the fold).
4. **In case of sloping roof**, minimum clearance height shall be 2.2 mts (measured from the lowest point of the roof). The average height of the room shall not be less than the minimum clearance height as applicable according to the building use and stipulated above.

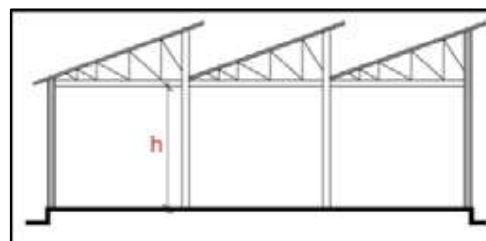

5. **In case of trussed roof**, minimum clearance height shall be measured from the floor level to the bottom of the tie beam and shall be 2.8 mts.
6. **For Hollow Plinth**, from finished ground level to finished next floor level provided for the purpose of parking shall have maximum clear height of 3.5 mts.

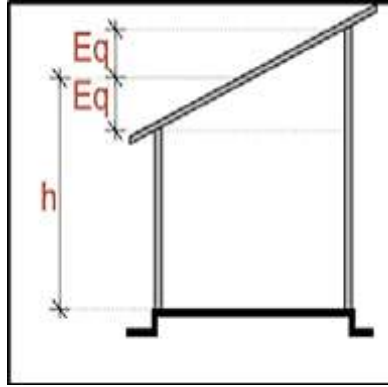

7. **For Basement**, exclusively used for parking shall have minimum clear height of 2.8 mts, and maximum clear height of 4.5 mts. in case of mechanical parking more height may be permitted.

13.1.8 Mezzanine

Mezzanine floor shall have a minimum clear height of 2.1 mts which may be allowed in a room at a minimum clear height of 2.1 mts from the finished floor level if; the area does not exceed 30 % of the area of the enclosed space.

13.1.9 Loft

Loft of a maximum height of 1.2 mts may be allowed in a room at a minimum clear height of 2.1 mts from the finish floor level if the area does not exceed 30 % of the area of the enclosed space.

13.1.10 Basement

1. Basement is allowed within a building-unit as per Regulation no 6.8 in Part II.
2. The area available after providing the required margins may be utilized for basement, as per Regulation no. 6.7.2 in Part II.
3. It may be provided at more levels, as per Regulation no. 6.8 in Part II.
4. Basement in a building shall have a minimum clear height of 2.8mts or as per Regulation no. 6.8 in Part II.
5. If basement is used for parking, vehicular ramps shall be provided as specified in Regulation no 6.7.3 and Regulation no.13.1.14 in Part II.
6. In cases where the permitted margin of the basement is lesser than the permitted margin of the super structure, no level difference shall be permitted in the marginal space of the building. Such marginal space shall be open to sky and motorable as per Fire Prevention and Life Safety Measures Regulation-2016 and amended from time to time.
7. During construction of basement, necessary shoring and strutting including sheet piling shall be required.
8. Provision for drainage or water supply shall not be permitted in the basement.
9. Material used for construction of basement shall be fire resistant. Wood or any other combustible material shall not be used as structural members of a basement.
10. No direct entry from the road shall be permitted to the basement. Access to the basement to be provided as per Fire Prevention and Life Safety Measures Regulation-2016 and amended from time to time.

13.1.11 Railings

1. A parapet/railing with a minimum height of 1.15 mts from the finished floor level shall be provided to ensure safety at all accessible edges of a building such as roof edges, staircase, terrace, balcony, floor edges or any large openings and/ or fully glazed window.
2. Railing for staircase shall be as per Fire Prevention and Life Safety Measures Regulation - 2016 and amended from time to time.
3. The maximum dimension of the railing/parapet perforations shall not exceed 0.15 mts.
4. In buildings meant for predominant use by children, it will be necessary to suitably alter the height of the fixtures.
5. Hand – rail for any level difference shall be provided with a pipe of minimum diameter of 40 mm and as illustrated across.

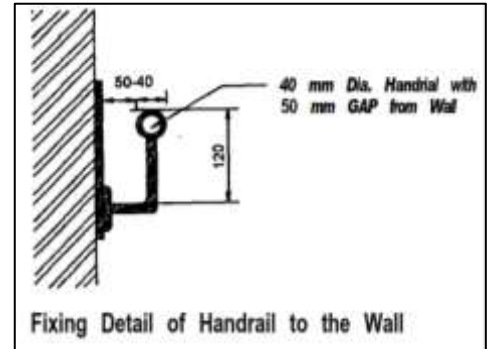

13.1.12 Terrace

Terrace of a building shall be accessible by a common staircase and be free from partitions.

13.1.13 Staircases, corridors and Passageway

13.1.13.1 Staircase in a building and its specifications shall be determined as mentioned in the table below. The minimum width of the flight shall be exclusive of parapet and floor-mounted railing.

Table 13.2 Staircase detail

No	Use	Height of Building (mt)	Staircase			Max. Travel Distance (mt.)	
			Min. Flight Width (mt)	Min. Tread (mm)	Max. Riser (mm)		
(1)	(2)	(3)	(4)	(5)	(6)	(7)	
1.a	Dwelling-1&2 (for residential use)	Three floor, up to ≤12	1.0	250	200	25(R)	25 (N.R.)
		>12	1.2	250	180		
1b.	Dwelling-3 (for residential use)	≤12	1.2	250	180	25(R)	25 (N.R.)
1c.		>12 & ≤25	1.5	250	180		
1d.		>25	2.0	300	160		
2a	Non Residential Use except industrial and assembly Use	≤25	1.5	300	160	25	
2b.		>25	2.0	300	160		
3	Assembly	For all heights	2.0	300	160	25	
4	Industrial	For all heights	1.5	300	160	25 (N.R.) 20 (HZ)	

“R” means Residential
 “N.R.” means Non-residential Use, Mixed-Use
 “HZ” means Hazardous

Note: It shall be permitted to provide two staircases of width 1.5 mts as an alternative of one staircase of 2.0mts, two staircases of width 1.2 mts as an alternative of one staircase of 1.5 mts within the travel distance as specified in table 13.2 above.

1. Staircase for basement:
 - a. The staircase to the basement shall have the same width as the regular staircase leading to upper floors.
 - b. Any staircase leading to the basement shall be as per Fire Prevention and Life Safety Measures Regulation-2016 and amended from time to time.
 - c. A staircase shall be provided from the lowest level of the basement as a means of access or exit at a travel distance mentioned in the table no. 13.2.
2. Staircase for all buildings other than detached and semi-detached dwelling units: Separate staircase shall be provided if the ground floor or any other floor in a residential building is used for non-residential purpose.
3. For all buildings, staircase shall be compliant with Fire Prevention and Life Safety Measures Regulation-2016 and amended from time to time.-

13.1.13.2 Corridors and Passageway

1. **For all buildings except Dwelling 1:** The minimum clear width of corridors and passageway shall be as under:

Table 13.3 Corridors and passageway

Length of corridor (in mts)	Width of corridor (mts)	
	Residential	Non-Residential
(1)	(2)	(3)
Up to 6	1.2	1.2
Up to 9	1.2	1.5
Up to 15	1.2	2.0
Above 15 and up to 24	1.5	2.5
24 and above	2.0	3.0

1. Corridor shall be clear of any obstructions. No projection in any form shall be allowed up to a height of 2.1mts from floor level.
2. The minimum height of Corridor shall be 2.10mt. from finished floor Level.
3. In case of any level difference in a corridor, a slope shall be provided with gradient not more than 1:12. In such case, guiding floor material shall be provided.
4. In case of all type of building height is more than 15.0mt. and no natural ventilation on either side of corridor, in such type of buildings, smoke exhaust system having make-up air and exhaust air system or alternatively pressurization system with supply air system for these exit access corridors shall be required.

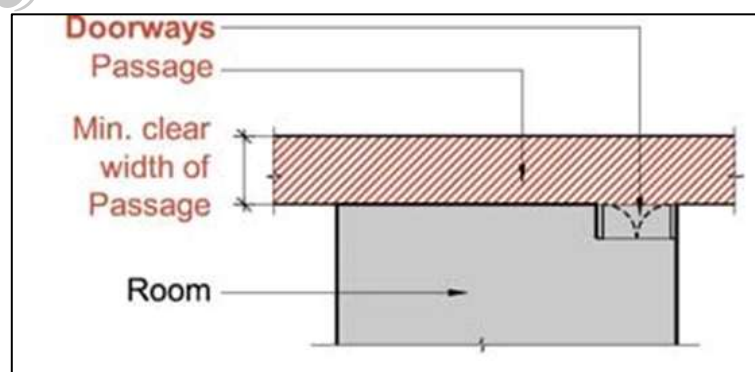

13.1.14 Ramp

1. Ramp for Vehicular Access

- a. Minimum width and radius for a ramp for two-wheelers, cars and trucks, respectively are specified in the table below:

Table 13.4 Minimum width of ramp and radius of inner curve based on type of vehicles

Vehicle	Minimum width of ramp (mt.)	Minimum radius of inner curve (mt.)
(1)	(2)	(3)
Two-wheeler	2.0	2.0
Car	3.0	3.0
Truck	6.0	4.0

- b. The maximum slope of ramp shall be 1:7.
 c. A level platform of width equal to ramp width and length of minimum 4.5 mt. shall be provided at end of the ramp at ground level and basement level.
 d. A minimum clear height of 2.6mts shall be maintained at all points on the ramp.
 e. For parking in basement/s, the number and width of ramp shall be provided as specified below and as per 13.5(as applicable):

Table 13.5 Ramp details based on area of parking in basement

Area of Parking in Basement	Number of Ramps	Width of Ramp
(1)	(2)	(3)
≤750sq.mt	1	3.0mt
>750sq.mt	1	6.0mts
	2	3.25mts each

2. **Ramp for Pedestrians:** For buildings exceeding 4mts height with following uses: Institutional, Assembly, Public Institutional, Educational-2, Mercantile and Business; a pedestrian ramp shall be provided unless provision for a lift is made as per Regulation 13.12. The ramp shall be provided with the following specifications:

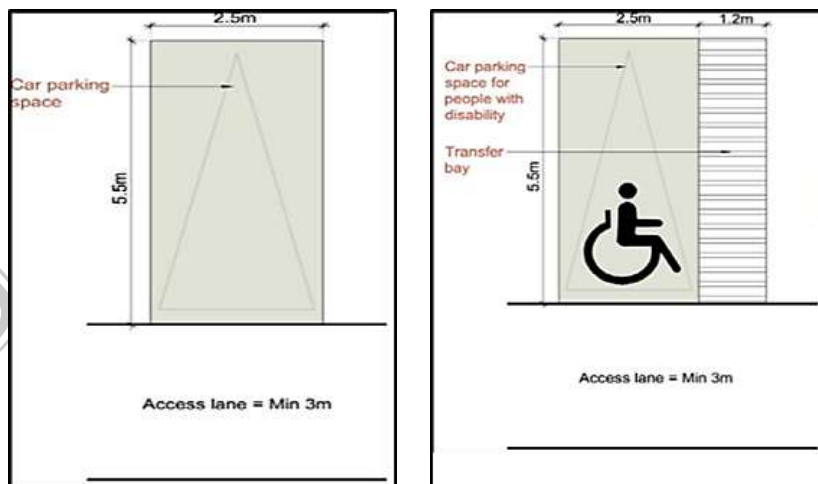

- a. The minimum width of the ramp shall be 1.2 mts, 1.5 mts and 1.8 mts for the ramp length of 3.6 mts, up to 9.0 mts and more than 9.0 mts respectively.
 b. A landing shall be provided of 1.5 mts depth for every 9 mts length of the ramp.
 c. The slope of a ramp shall not exceed 1 :12
 d. Surface of the ramp shall be slip-resistant and the edge of the ramp shall be protected with a minimum height of 100mm.

- e. Handrails on the ramps shall be on both sides at two levels; at 700mm and 900mm, both ends shall be rounded, grouted and extended 300 mm beyond top and bottom of ramp.
- f. Entrance landing shall be provided at the starting and ending level of the ramp with the minimum length equal to 1.8 mts.
- g. Ramps shall lead directly to outside open spaces at ground level or courtyards or other safe places

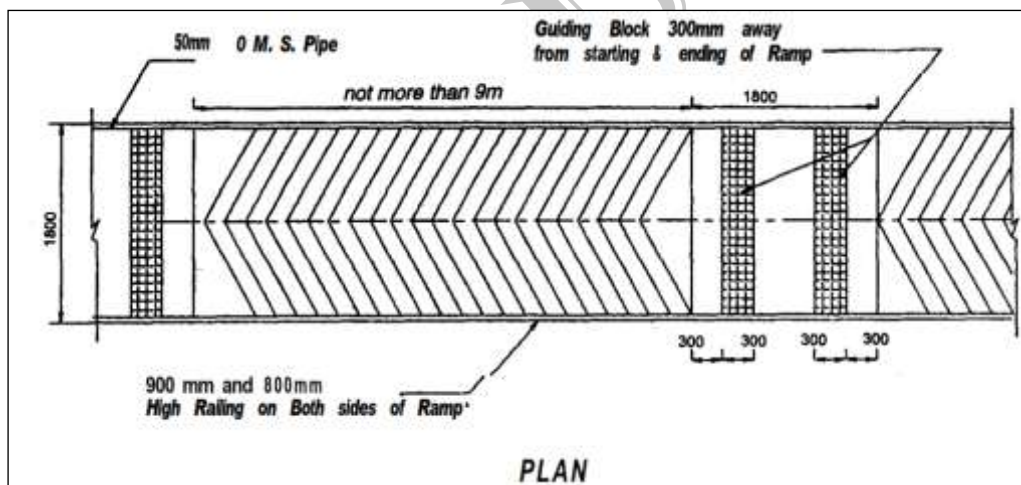
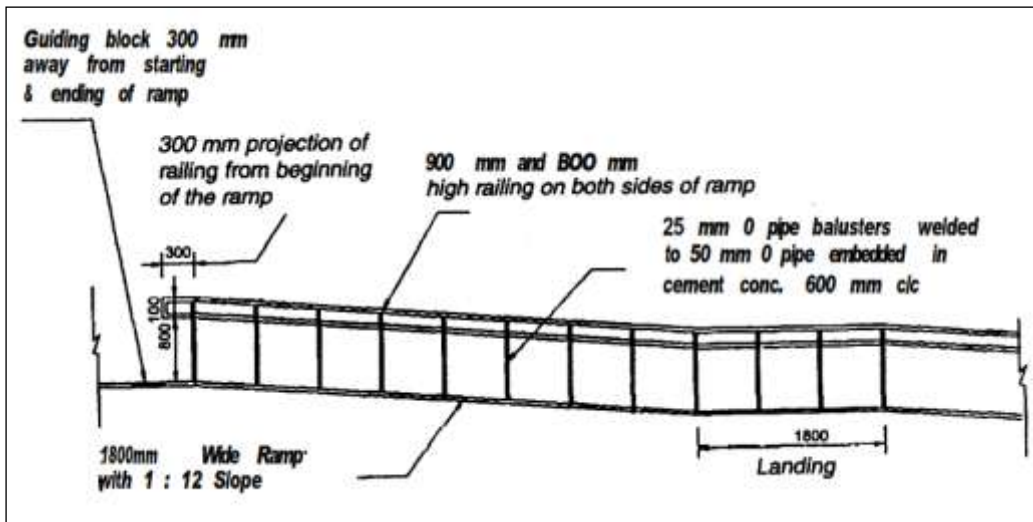

3. Ramp for Fire Tender:-

- a. For parking except basement/s, hollow plinth at ground level and ramp leading to parking above ground level at any floor shall be permissible in side/rear margin are subject to any site/building unit which fulfills following minimum requirement in case of building height exceeds 25 mt.

Table 13.6 Ramp for Fire Tender

Requirements	
Minimum Gross Operational weight	30 Tonne
Minimum Overhead Clearance	4.5 mt
Minimum Width of Fire Appliance Accessway	3.5 mt
Minimum Width of Perimeter Vehicular Access for Large Isolated Building	6.0 m
Minimum Lateral Clearance	2.0 m

Table 13.6 Ramp for Fire Tender

Requirements	
Hardstanding	6.0 m wide x 15.0 m long
Minimum Turning Circle Kerb / Kerb	24.0 m
Minimum Turning Circle Wall/ Wall	28.0 m
Maximum Dead-end	45.0 m
Maximum Gradient	1:15

4. Turning Facilities

Fire appliance access way dead-ends shall not exceed 45mt not be less than 15mt in length. If exceeding 45mt, then turning facilities at the dead-end (a turning circle or a hammerhead) must be provided as shown in Figure below.

The outer radius for turning in an access way and fire appliance access road shall comply with the requirements noted in Figure below.

(a) Turning facility for fire appliance

(b) U-turn facility for fire appliance

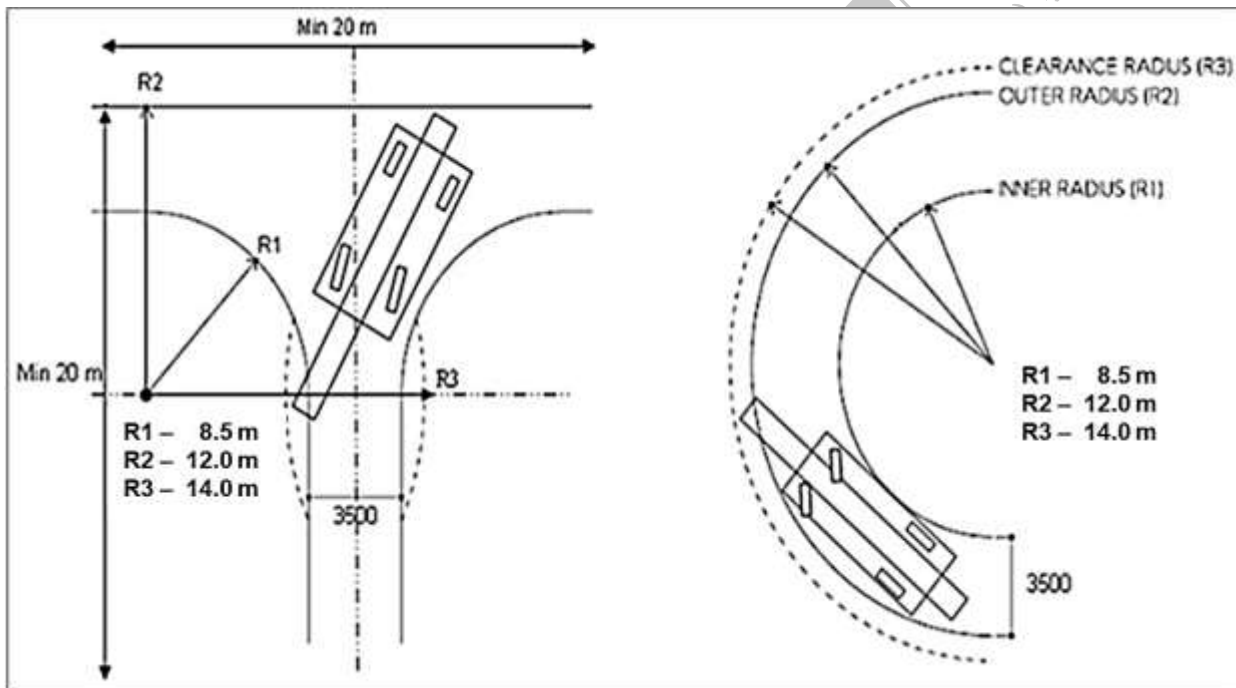

13.2 Parking

13.2.1 Parking to be provided

In any building, provision for parking shall be made as per requirements specified in Part II, planning regulation or as per Schedule No.16 in Part I.

1. Parking for people with disability shall be provided for all buildings and facilities other than dwelling -1&2 as per Performance Regulation 13.2.2.

13.2.2 Design of Parking for Cars

Parking layout for cars in all buildings shall conform to the following specifications:

1. Minimum dimension of a space provided for parking a car shall be 2.5 mts x 5.5 mts.
2. Each car parking space should be connected to the street providing access to the building-unit by means of an access/exit lane.
3. Minimum width of the access/exit lane for single-sided parking shall be 3 mts and for double-sided parking layout, the minimum width of the access lane shall be 5.5 mts.
4. A minimum clear height of 2.6 mts shall be maintained at all points in the parking space and access/exit lanes.
5. Minimum provision of two accessible car parking space shall be provided for people with disability for every 25 car parking spaces or less. This accessible car parking space shall:
 - a. have a minimum bay width of 2.5 mts
 - b. have a 1.2 mts side transfer bay. This can be shared by two successive parking bays.
 - c. be located within 30 mts from the main entrance of the building
 - d. have appropriate signages indicating that the space is reserved for wheel chair that are conspicuously displayed as specified in Regulation 13.7
 - e. have guiding floor materials or have a device to guide visually impaired persons with audible signals or any other devices which serves the above purpose.
 - f. Minimum 50% of the parking reserved for visitors shall be provided at ground level.

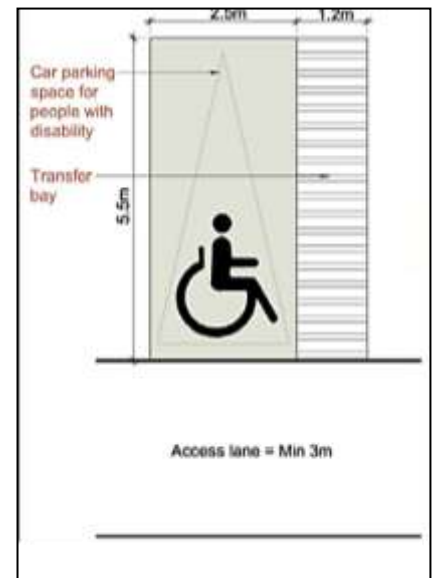
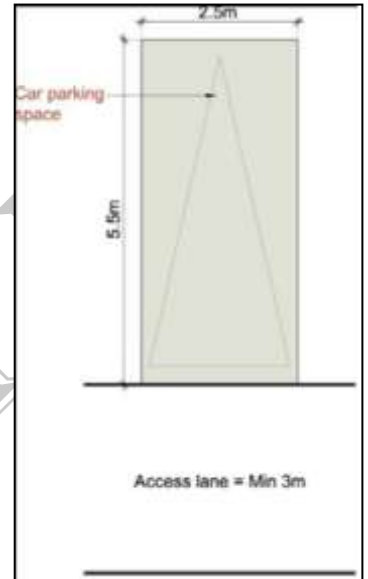

13.2.3 Design of Parking for Two-Wheelers

Parking layout for two-wheelers in all buildings shall conform to the following specifications:

1. Minimum dimension of a space provided for parking a two-wheeler shall be 0.90 mts x 2.0 mts.
2. Each two-wheeler parking space should be connected to the street providing access to the building-unit by means of an access/exit lane. Minimum width of the access/exit lane shall be 2.0 mts.
3. A minimum clear height of 2.6 mts shall be maintained at all points in

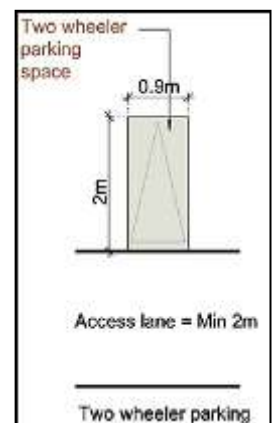

the parking space and access/exit lanes.

13.2.4 Design of Parking for Trucks

Parking layout for trucks in all relevant buildings shall conform to the following specifications:

1. Minimum dimension of a space provided for parking a truck shall be 4.0mts. X 8.0mts.
2. Each truck parking space should be connected to the street providing access to the building-unit by means of an access/exit lane. Minimum width of the access/exit lane shall be 6.0mts.

Explanation: The aforesaid regulation no.13.2.4 shall be applicable only when a parking layout/ space is required to be designed for trucks.

13.2.5 Specified Parking for loading and unloading

1. Loading and unloading space shall be provided as per regulation no. 6.15.(8) of part II in Industrial, Storage and Mercantile 1, 2, 3 except the following :-

Shops/ shopping center/ shopping malls having aggregate carpet area up to 1000 sq.mt., Restaurant, Hospitals of any category, Nursing home, Business, Light Home Workshop, Activity related to IT, call center and training center, Laboratory.

2. In case of mixed development, the loading and unloading space shall be provided for the area referred in (1) above on prorata. Such loading unloading space requirements shall be provided in a manner that 3.5 mt. x 7.5 mt. shall be provided at the rate of one space for every 1000 sq.mt of Carpet area or part thereof.
3. The ramps leading to loading and unloading space provided as per (1), (2) shall have minimum 6.0 mt width. Such ramp provided for loading unloading may also be used for the purpose of approach to parking.
4. The loading and unloading space shall be permitted on ground level or in first basement. And shall be considered as a part of parking area

13.3 Lighting

Adequate natural and artificial lighting as published in the National Building Code of India, Part VIII – Building Services, Section I, shall be provided in all parts of a building to the satisfaction of the Competent Authority.

13.4 Ventilation

13.4.1 Ventilation of Rooms

1. Every habitable and usable room shall be equipped for adequate ventilation by provision of windows and/or ventilators that open directly into an open space or semi-open space such as courtyard or verandah. The size of such an open space shall be minimum one-tenth of the floor area of the room.
2. The aggregate of all openings including doors, windows and ventilators in a room shall be minimum one-seventh of the floor area of the room.
3. Any deficiency shall be compensated by use of mechanical system such as blowers, exhaust fans or air conditioning system according to the standards in Part VIII Building Services, Section-I Lighting and Ventilation, National Building Code and to the satisfaction of the Competent Authority.

13.4.2 Ventilation of Basement

Every basement shall be ventilated adequately for its respective use. Vent duct openings shall be permitted at building-unit level in accordance with as Fire Prevention and Life Safety Measures Regulation-2016 and amended from time to time. Any deficiency shall be compensated by use of mechanical system such as blowers, exhaust fans or air conditioning system according to the standards in Part VIII Building Services, Section-I Lighting and Ventilation, National Building Code, and to the satisfaction of the Competent Authority.

13.4.3 Ventilation of Atrium

Any atrium covered from top shall be provided with adequate provision of light and ventilation.

13.4.4 Ventilation of Bathrooms and Water Closets

1. Every bathroom and water closet shall be ventilated adequately.
2. At least one of the walls of a water closet or bathroom or sanitary block shall have an opening of minimum 0.25 sq.mt. for each unit of W.C or bathroom. Such opening shall open into an open to sky space with minimum dimension of 0.9mts X 0.9mts.
3. Any deficiency shall be compensated by use of mechanical system such as blowers, exhaust fans or air conditioning system according to the standards in Part VIII Building Services, Section-I Lighting and Ventilation, National Building Code, and to the satisfaction of the Competent Authority.

13.4.5 Ventilation of Staircase for Dwelling-1 & 2

1. **For ventilation by windows:** Every staircase shall be ventilated adequately from an open air space with a minimum area of 1sq.mt. The aggregate area of all windows provided shall be at least 1.2sq.mt at each stair landing or floor in the enclosing wall of the staircase which abuts on such 1sq.mt open air space.
2. **For mechanical ventilation:** Any deficiency shall be compensated by use of mechanical system such as blowers, exhaust fans or air conditioning system according to the standards in Part VIII Building Services, Section-I Lighting and Ventilation, National Building Code, and to the satisfaction of the Competent Authority.

13.4.6 Ventilation of Industrial Buildings

1. Every usable room shall be equipped for adequate ventilation by provision of windows, ventilators, skylights or artificial means.
2. For natural ventilation, every room in such building shall be lit and ventilated by adequate number of windows, ventilators and sky lights exclusive of doors having clear opening not less than 1/7th of the floor area abutting on open air space of width not less than 1/3rd of the height of the part of the building abutting such open space.
3. Any deficiency shall be compensated by use of mechanical system such as blowers, exhaust fans or air conditioning system according to the standards in Part VIII Building Services, Section-I Lighting and Ventilation, National Building Code and to the satisfaction of the Competent Authority.

13.4.7 Ventilation of Special Buildings

1. Every auditorium, halls and other special buildings shall be naturally lit and ventilated by doors, ventilators and windows abutting on an interior or exterior open air space which shall not be less than 1/5th of the total floor area.

2. Any deficiency shall be compensated by use of mechanical system such as exhaust fans or air-conditioning system according to the standards in Part VIII Building Services, Section-I Lighting and Ventilation, National Building Code, and to the satisfaction of the Competent Authority.

13.4.8 Change of ventilation system

No permission shall be granted to convert an existing air-conditioned theatre to a non-air-conditioned theatre.

13.5 Heating and Air Conditioning

Adequate heating and air conditioning as published in the National Building Code of India, Part VIII – Building Services, Section 3- Air Conditioning, shall be provided in all parts of a building and to the satisfaction of the Competent Authority.

13.5.1 Air-Conditioning of Special Buildings

Auditorium or cinema halls shall be air-conditioned as per following specifications:

1. Temperature Range- 22 to 26.5 degrees Celsius (72° F to 80° F).
2. Change of Air per hour- approximately 10 times.
3. Relative Humidity- 50 to 60%
4. Fresh Air Requirement- 7.5 CFM per person.

13.6 Water related Requirement

13.6.1 Water Storage Tank

Water storage tank shall be maintained to be perfectly mosquito proof condition, by providing a properly fitting hinged cover and every tank more than 1.50 mt. in height shall be provided with a permanently fixed non-ferrous metal ladder to enable inspection by anti- malaria staff.

13.6.2 Drinking Water Supply

In all buildings other than residential buildings, suitable provision of drinking water shall be made for the people with a disability near the accessible toilet provided under Performance Regulation 13.9.2.

13.7 Signage

Signage directly pertaining to the use of the building may be erected on the plot.

For all Buildings other than Dwellings-1&2:

Signage pertaining to the internal building uses shall be provided. Such signage shall comply with the following:

1. The size of lettering shall not be less than 20mm to enable easy legibility.
2. Public Address System may also be provided in busy public areas.
3. The symbols or information should be in contrasting colour and properly illuminated to help people with limited vision to differentiate amongst primary colours.
4. International symbol mark for wheel chair as shown below be installed at the lift, toilet, staircase, parking areas etc., that have been provided for people with a disability.



5. For educational, institutional and government buildings- information board in Braille shall be installed on a wall near the entrance at a suitable height. It should be possible to approach them closely. To ensure safe walking, there should not be any protruding sign which creates obstruction in walking.

13.8 Letter Box

In all case of building having more than two floors including ground floor a letter box for each separate unit shall be provided at ground floor level to facilitate easy mail delivery.

13.9 Sanitation

Minimum sanitary accommodation shall be provided for all proposed buildings and additions and extensions to existing buildings.

13.9.1 For Residential Buildings

The minimum sanitary requirement for a residential dwelling unit shall be one water closet of minimum 0.9 sq.mt area.

13.9.2 For All Buildings other than Residential

1. Minimum one special water closet shall be provided for the use of persons with disability with provision of washbasin and drinking water at the ground level.
 - a. Minimum size of toilet shall be 1.5 mt. X 1.75 mt
 - b. Minimum width of door shall be 900mm with outward door swing.
 - c. Suitable arrangement of vertical or horizontal hand rails with 50mm clearance from the wall shall be provided.
 - d. W.C. seat shall be 500mm from the floor.
2. Water closets shall be provided for each gender with a minimum area of 0.9 sq.mt area.
 - a. The number of water closets shall be decided on the basis of the maximum number of building users of that gender at any time and as specified in the table 13.7

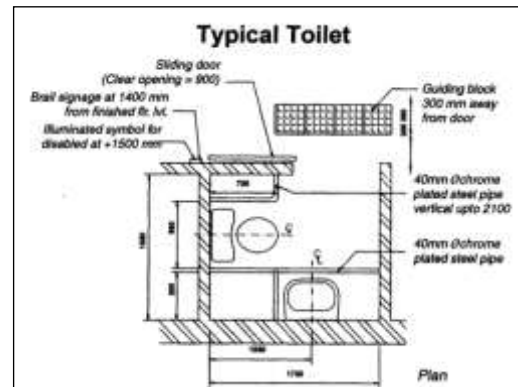

Table 13.7 Requirement of sanitation

Building Use	Rate for No. of Users	No. of Users	Min. No. of Urinals	Min. No. of Water Closets	Min. No. of Washbasins or Wash area
(1)	(2)	(3)	(4)	(5)	(6)
Educational	1 user per sq. mt per carpet area		5 or 1 per 50 male users or less, whichever is more	2 or 1 per 200 users or less per gender, whichever is more	
Business	1 user per 4sq.mt per carpet area	<20	1 may be provided	1 WC per gender each	
		21-100	1 per 25 male users or less	1 per 25 users or less per gender	
		101-500	1 per 50 male users or less	1 per 50 users or less per gender	
		>500		1 per 100 users or less per gender	
Industrial, Storage	1 user per 25sq.mt of carpet area	1-100	1 per 100 male users or less	1 per 25 users or less per gender	
		>100	1 per 50 male users or less	1 per 50 users or less per gender	4 sq.mt of wash area
Special Buildings	1 user per seat		2 per 75 users or less	1 per 100 users or less per gender	1 washbasin per 200 users or less

Note: Carpet Area Means Carpet Area defined in RERA Regulation.

3. Minimum 25% of such water closets and urinals shall be provided in common and accessible locations of the building.
4. These sanitation facilities shall be provided with signage indicating the use and the intended users' gender as per Performance Regulation no. 13.7.

13.9.3 For Special Buildings

The number of water closets shall be decided on the basis of the number of seats provided. Water closets shall be provided for each gender, apportioned suitably.

13.10 Drainage

The manner in which it is intended to connect the drainage system of a building to a public sewer shall be subject to approval by the Competent Authority. Regulations for construction, maintenance, and control of drains, sewers, drainage and sewage works of any description within Development Area shall be as per the norms of Gujarat Pollution Control Board.

13.10.1 Provision of Septic Tank, Seepage Pit and Soak Well

In the case where there is no drainage facility available for the land to be developed, the owner shall provide septic tank, soak pit or soak well for disposal of sewage and waste water.

1. Location and sub-soil dispersion: A sub-soil dispersion system shall not be closer than 12mts to any source of drinking water, such as a well, to mitigate the possibility of bacterial pollution of water supply. It shall also be as far removed from the nearest habitable building is economically feasible but not closer than 2mts to avoid damage to the structure.
2. Dimensions and Specifications:
 - a. Septic tank shall have a minimum inner width of 75cms. a minimum depth of - meter below the water level and a per capital minimum liquid capacity of 85 liters. The length of the tanks shall be least twice the width.
 - b. Septic tanks may be constructed of brick work, stone masonry, concrete or other suitable material as approved by the competent authority..
 - c. Under no circumstances should effluent from a septic tank or allowed into an open channel drain or body of water without adequate treatment.
 - d. The minimum normal diameter of the pipe shall be 100mm. Further at junction of pipes in manholes, the direction of flow from a branch connection should not make an angle exceeding 45 degrees with the direction of flow in the main pipe.
 - e. The gradients of land-drains, under-drainage as well as the bottom of dispersion trenches and soak wells should be between 1:300 and 1:1400.
 - f. Every septic tank shall be provided with a ventilating pipe of at least 50mm diameter. The top of the pipe shall be provided with a suitable cage of mosquito proof wire mesh. The ventilating pipe shall extend to a height which would cause no smell or nuisance to any building in the area. Generally, the ventilating pipe should extend to a height of about 2mts above the septic tank building when it is located closer than 15mts.
 - g. When the disposal of a septic tank effluent is to a seepage pit, the seepage pit may be of sectional dimension of 90cms and not less than 100cms in depth below the inner level of the inlet pipe. The pit may be lined with stone, brick and concrete blocks with dry open joint which should be backed with at least 7.5cms of clean coarse aggregate. The lining above the inlet level should be narrowed to reduce the size of the R.C.C. cover slabs. Where no lining is used, especially near trees, the entitle pit should be filled with loose stones. A masonry ring should be constructed at the top of the pit to prevent damage by flooding of the pit by surface run off. The inlet pipe should be taken down to a depth of 90cms from the top an anti-mosquito measure.
 - h. When the disposal of septic tank effluent is to a dispersion trench, the dispersion trench shall be 50 to 100cms wide, excavated to a slight gradient and shall be provided with a layer of shed gravel or crushed stones 15 to 25cms deep. Open, joined pipes placed inside the trench shall be made of unglazed earthenware clay or concrete and shall have a minimum internal diameter or 70 to 100mm. Each dispersion trench should not be longer than 30mts and trenches should not be placed closer than 1.8mts to each other.
 - i. The above mentioned Regulations shall be subject to modification form time to time as required by Gujarat Pollution Control Board/ Competent Authority.

- j. In the case where there is no drainage facility available for the land to be developed, the owner shall provide septic tank, soak pit or soak well for disposal of sewage and waste water.

13.11 Electrical Infrastructure

Adequate electrical infrastructure as published in the National Building Code of India, Part VIII - Building Services, Section 2- Electrical Installations, shall be provided in all buildings to the satisfaction of the Competent Authority.

13.12 Lifts and Elevators

13.12.1 For buildings exceeding 4mts height with following uses: Institutional, Assembly, Public Institutional, Educational-2

Minimum one lift shall be provided to access public areas on floors above ground level.

13.12.2 For buildings exceeding 10 mts height

- For buildings with height more than 10mts, lifts shall be required as per the following table no: 13.8

Table 13.8 Provision For Passengers Lift

No.	Building Use	Height of Building	Minimum no. of Lifts (whichever is more from column A and B)	
			A	B
1.	Dwelling	Above 10mts	Minimum 1, or	1 Lift per thirty dwelling units (excluding dwelling units on ground level and two upper floors or Hollow- plinth and two upper floors)
		Above 25mts	Minimum 2, or	
2.	Non-residential	Above 10mts	Minimum 1, or	1 Lift per 1200 sq.mt built-up area (excluding area on ground floor and two upper floors or Hollow-plinth and two upper floors)
		Above 25mts	Minimum 2, or	

Note :

- In case of D3 category, for building exceeding 11 mt. height minimum 1 lift shall be required.
- If, DW-1 and DW-2 type building having building height up to & equal to 12.0 mt from G.L. then provision for requirement of lift shall not be applicable.

2. For buildings with height above 21.0mts, one of the required lift shall be a fire lift, in conformity with Fire Prevention and Life Safety Measures Regulations – 2016 and amended from time to time.

3. For buildings having parking at other than ground floor and for accessibility ramp is not provided, in such cases building shall be provided with vehicular lift as per table No. 13.9. in addition to requirement of passenger lift as per Reg. No. 13.12.2 (1 & 2) and Reg. No. 13.12.3

Table 13.9 Size of Vehicle Lift shall be according to weight of Car:-

Sr. No.	Use	Weight of Car/ No.of Vehicle	Size (mt. x mt.)
(1)	(2)	(3)	(4)
1	Residence Affordable Housing	3000Kg/2 nos. of car	3.80x6.45
2	Other than RAH type	3000Kg/1.5 nos. of car	3.80x6.45
3	Non-Residence/Mix Use on other than up to F.F.(other than Ind.)	4 000 kg/2 Nos. of Car	4.30x6.95

Note: Average vehicle occupancy may be considered as

- 1.5 per car for office car parks,
- 4 for airports and retail and 2 elsewhere.

4. Multi-Level Car-Parking:

- Number of car lifts ensuring that average car retrieval/parking time does not exceed 2 min.
- The sizing of the car lifts has to be adequate to fit the largest vehicle that is intended to be transported as well as adequate space to enable opening of the doors to enable evacuation of passengers in the eventuality of an entrapment.
- Designers will also need to take into account the probability of queues developing and provide for holding lanes as per regulation no.13.2.2 of Part-III.

13.12.3 General Requirements for Lifts and Elevators

- Lift shall be provided from the ground level or lower level.
- Minimum capacity of the lift shall be for six persons.
- Lifts of either or 6, 8, 12 and/or 24 persons capacity can be permitted, as considered by Competent Authority as per the peak hour passenger volume. However more than 1 lift shall be provided as per requirement of Fire Prevention and Life Safety Measures Regulations – 2016 and amended from time to time.
- A clear door opening with minimum width of 900 mm shall be provided. A clear landing area in front of the lift doors shall have minimum dimensions of 1.8mts x 2.0mts or more.
- A handrail of 600 mm length shall be provided at a height of 1 mts from the floor of the lift car.
- The duration of an automatic closing lift door shall be minimum 5 seconds with a maximum closing speed of 0.25 mt/sec.
- The interior of the lift cabin shall be equipped with a device that audibly indicates the floor level reached and whether the door of the cabin is open or closed.
- Number and type of lifts to be provided in different types of buildings shall conform to standards specified in the National Building Code of India, Part VI
- II - Building Services, Section 5- Installation of Lifts and Escalators.

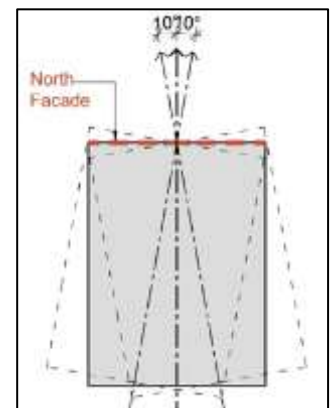

All lifts shall also meet Fire Prevention and Safety requirements specified in Performance Regulation as well as Fire Prevention and Life Safety Measures Regulations – 2016, and amended from time to time applicable on the basis of height of the building.

13.13 External Façade

On the external facade of any building, the glazed surface area of the façade shall be non-reflective and provided up to a maximum of 50% of the total surface area of each facade, with the provision of safety railing up to sill level. On the North facade, entire surface area may be glazed. 10 degrees deviation may be permitted in consideration of the Northern facade as illustrated.

13.14 Display Structures

1. The size and location of permitted billboards along roads shall be permitted as per Regulation no 11.1 in Part II.
2. Every billboard shall be designed as per the requirements for structural safety as prescribed in Regulations 16.8.
3. Billboards on roof tops are not permitted unless the entire roof is constructed with non-combustible materials.

13.15 Occupant Load

1. The occupant load in dormitory portions of homes for the aged, orphanages or mental hospitals, etc. where sleeping accommodation is provided shall be calculated at not less than 13.3 persons per 100 sq.mt.
2. The plinth or covered area shall include, in addition to the main assembly room or space, any occupied connecting room or space in the same storey or in the storeys above or below where entrance is common to such rooms and space and the area available for use by the occupants of the assembly place. No deduction shall be made in the plinth/covered area for corridors, closets and other sub-divisions; that area shall include all space serving the particular assembly occupancy.

Table 13.8 Occupant Load

Sr. No.	Type of Occupancy	Occupant Load per 100 sq.mt. of Plinth or Covered Area	
(1)	(2)	(3)	
1	Residential	8.0	
2	Educational	25.0	
3	Institutional	6.60	
4	Assembly	without seating facilities including dining rooms	166.6
		with fixed or loose seats and dance floor	66.6
5	Mercantile	street floor and sales basement	33.3
		upper sale floor	16.6
6	Business and industrial	10.0	
7	Storage	3.3	
8	Hazardous	10.0	

14. FIRE PREVENTION AND SAFETY

Fire Prevention and Life Safety Measures shall be as per Fire Prevention and Life Safety Regulations-2016 and as amended from time to time.

14.1 Requirement for Fire Safety Professionals in Buildings

14.1.1 Fire Officer

The minimum qualifications for Fire Officer shall be as listed in Schedule 14. Suitable persons shall be registered with the Chief Fire Officer.

14.1.2 Fire Men

The minimum qualifications for Fire Men shall be as listed in Schedule 14. Suitable persons shall be registered with the Chief Fire Officer.

14.1.3 Applicability of Fire Safety Professionals

The applicability of the fire safety professionals for buildings is provided as per Schedule 5.

15. SPECIAL BUILDINGS PERFORMANCE REGULATIONS

The following regulations shall be applicable for all Special Buildings in addition to the other performance regulations.

15.1 Visibility

Auditorium or cinema halls shall provide minimum visibility requirements as per following specifications:

1. The seat nearest to the screen shall not be nearer than the effective width of the normal picture (ratio 1:1.33). This distance shall be 3/4 in case of cinema scope and other wide angles techniques and one half in case of 70mm presentations.
2. The elevation of the balcony seats shall be such that line of sight is not inclined more than 30° to the horizontal.
3. The seats should preferably be staggered side-ways in relation to those in front, so that a spectator in any row is not looking directly over the head of the person immediately in front of him.
4. The position and height of the screen shall be regulated in such a way that the maximum angle of the line of vision from the front seat to the top of the screen shall not exceed 50° .

15.2 Mixed Occupancy

1. Places of assembly in buildings of other occupancy, such as all rooms in hotels, restaurants in stores and assembly rooms in schools, shall be so located, separated or protected as to avoid any undue danger to the occupants of the place of assembly from a fire/smoke originating in the other occupancy, No mix development shall be permitted with the buildings having height more than 45mt. OR Commercial and residential use shall be separated by provision of service floor. Service floor having maximum clear height of 2.1 mts from beam bottom to finished floor level, service floor can be provided at any floor in a building.
2. Every place of assembly, every tier of balcony, and every individual room used as a place of assembly shall have exits sufficient to provide for the total capacity therein as required such that door width for assembly building shall not be less than 2000 mm. for every 600 person.
3. Every place of assembly shall have at least four separate exits as remote from each other as practicable.
4. At least one row of seating area shall be made accessible by ramps or elevators for disabled visitors.
5. Clear aisles not less than 1.2 mt in width shall be formed at right angles to the line of seating in such number and manner that no seat shall be more than seven seats away from an aisle. Rows of seats opening to an aisle at one end only shall have not more than seven seats. Under the condition, where all these aisles do not directly meet the exit doors, cross- aisles shall be provided parallel to the line of seating so as provide direct access to the exit, provided that not less than one cross aisle for every 10 rows shall be required. The width of cross-aisles shall be minimum of 1 m. Steps shall not be placed in aisles to overcome differences in levels, unless gradient exceeds 1 in 10.
6. The fascia of boxes, balconies and galleries shall have substantial railings not less than 1000 mm high above the floor. The railings at the end of aisles extending to the fascia shall be not less than 1000 mm high for the width of the aisle or 1100 mm high at the foot of steps.

7. Cross aisles except where the back of seats on the front of the aisle project 600 mm or more above the floor of the aisle shall be provided with railings not less than 900 mm high.
8. No turnstiles or other devices to restrict the movement of persons shall be installed in any place of assembly in such a manner as to interfere in any way with the required exit facilities.
9. In theatres and similar places of public assembly where persons are admitted to the building at a time when seats are not available for them are allowed to wait in lobby or similar place until seats are available, such use of lobby or similar space shall not encroach upon the required clear width of exits. Such waiting shall be restricted to areas separated from the exit ways by substantial permanent partition or fixed rigid railing not less than 105 cm high. Exits shall be provided for such waiting spaces on the basis of 1 person for each 0.3 sq.mt. of waiting space/ area. Such exits shall be in addition to exits specified for the main auditorium area and shall conform in construction and arrangement to the general rules of exits given above.
10. No display or exhibit shall be so installed or operated as to interfere in any way with access to any required exit, or with any required exit sign.
All displays or exhibits of combustible material or construction and all booths and temporary constructions in connection therewith shall be so limited in combustibility or protected so as to avoid any undue hazard of fire which might endanger occupants before they have opportunity to use the available exits, as determined by the authority.
11. Places of assembly in buildings of other occupancy may use exits common to the place of assembly and the other occupancy, provided the assembly area and the other occupancy are considered separately, and each has exits sufficient to meet the requirements of the code.
12. Exits shall be sufficient for simultaneous occupancy of both the place of assembly and other parts of the building, unless authority determines that the simultaneous occupancy will not occur.
13. At least half the required means of exit shall lead directly outdoors or through exit ways completely separated from exits serving other parts of the building.
14. The decoration of place of assembly shall be of non-flammable materials. Fabrics and papers used for such purpose shall be treated with an effective flame retardant material. Stage settings made of combustible materials shall likewise be treated with fire retardant materials of class 1 flame spread.
15. Seats in places of public assembly, accommodating more than 300 persons, shall be securely fastened to the floor except as permitted in (o) below. All seats in balconies and galleries shall be securely fastened to the floor, except that in nailed-in enclosures like boxes with level floors and having not more than 14 seats, the seats need not be fastened. Tapestry of the seats shall be fire resistant.
16. Chairs not secured to the floor may be permitted in restaurants, night clubs and other occupancies where fastening of seats to the floor may not be practicable, provided that in the area used for seating, excluding dance floor, stage etc, there shall be not more than one seat for each 1.4sq.mt of floor area and adequate aisles to reach exits shall be maintained at all times.
17. Seats without dividing arms shall have their capacity determined by allowing 450 mt per person.
18. The spacing of rows of seats from back shall neither be less than 850 mm nor less than 700mm plus the sum of the thickness of the back and the inclination of the back. There

shall be a space of not less than 350mm between the back of one seat and the front of the seat immediately behind it as measured between plumb lines.

19. Rooms containing high-pressure boilers, refrigerating machinery other than domestic refrigerator type, or other service equipments subject to possible explosion shall not be located directly under or adjacent to required exits. All such rooms shall be effectively cut off from other parts of the building and provided with adequate vents to the outer air.
20. All rooms or areas used for storage of any combustible material or equipment, or for painting, refinishing, repair or similar purposes shall be effectively cut off from assembly areas or protected with a standard system of automatic sprinklers. They shall be located away from staircases.
21. Every stage equipped with fly galleries, grid irons and rigging for movable theater type scenery shall have a system of automatic sprinklers over and under such stage areas or spaces and auxiliary spaces, such as dressing rooms, store rooms and workshops. The proscenium opening shall be provided with a fire-resisting curtain, capable of withstanding a lateral pressure of 4 KN/ sq.mt. over the entire area. The curtain shall have an emergency closing device capable of causing the curtain to close without the use of power and when so closed, it shall be reasonably tight against the passage of smoke.
22. The stage roof of every theatre using movable scenery or having a motion picture screen of highly combustible construction shall have a ventilator or ventilators in or above it, open able from the stage floor by hand and also opening by fusible links or some other approved automatic heat/ smoke actuated device, to give a free opening equal to at least one-eighth the area of the floor of the stage.
23. The proscenium wall of every theatre using movable scenery or decorations shall have exclusive of the proscenium opening, not more than two openings entering the stage, each not to exceed 2 m² and fitted with self- closing fire resistant doors.
24. Automatic smoke vents actuated by smoke detectors shall be installed above the auditorium or theatres, including motion picture houses, with capacity of 8 air change per hour.

15.3 Institutional Buildings

These shall conform to those given in 6.3 Part IV NBC second revision but shall conform to NBC amended from time to time and particular attention is drawn to the following:

1. In building or sections occupied by bed-ridden patients where the floor area is over 280 sq.mt., facilities shall be provided to move patients in hospital beds to the other side of a smoke barrier from any part of such building or section not directly served by approved horizontal exits or exits from first floor (floor 2) of a building to the outside.
2. Not less than two exits of one or more of the following types shall be provided for every floor, including basements, of every building or section:
 - a. Doors leading directly outside the building.
 - b. Stairways
 - c. Ramps.
 - d. Horizontal Exits and
 - e. Fire Escape Staircase.
3. All required exits as per table in Regulation 22.4 of corridor width.
4. No building constructed in whole or in part of combustible materials shall be used to confine inmates in cells or sleeping quarters, unless automatic sprinkler protection is provided.

15.4 Public Safety

Closed Circuit Television (CCTV) Network shall be installed in public areas of assembly buildings and other places of entertainment as per protocols laid down by the Appropriate Authority.

U.D. & U.H.D.

16. STRUCTURAL SAFETY

16.1 Applicability

The following structural and seismic safety regulations shall apply to all buildings “as per Schedule – 6”.

16.2 Structural Stability and Maintenance of Existing Buildings

1. The Owner/ developer/ occupants and registered appointed Person on Record shall have the assessment of structural safety of an existing building/ structure damaged/ undamaged carried out at stipulated periodical intervals through expert(s) chosen from a panel of experts identified by the Competent Authority. The intervals for maintenance and inspection shall be as per Schedule 6.
2. The owner/developer/occupant on advice of such expert(s) shall carry out such repair/restoration and strengthening/retrofitting of the building found necessary so as to comply with the safety standards laid down in The National Building Code and the Indian standards as specified.
3. The owner/developer/occupant shall, after 15 years and later on every 10 years, obtain certificate of structural fitness of the building for the sanctioned use from Authorized person having expertise. in case, it is not compiled, the competent authority may take befitting action to discontinue the use of the building.
4. The Competent Authority may also direct the owner/developer/occupant, whether the building could be occupied or not during the period of compliance.

16.3 Additions and Alterations to Existing Buildings

An alteration or addition to an existing building that is not structurally independent shall be designed and constructed such that the entire structure conforms to the structural and seismic safety requirements for new buildings, unless the following three conditions are complied with:

1. The alteration or addition complies with the requirements for new buildings.
2. The alteration or addition does not increase the seismic forces in any structural element of the existing building by more than 5% unless the capacity of the element subject to the increased force is still in compliance with the requirements for new buildings.
3. The alteration or addition does not decrease the seismic resistance of any structural element of the existing building unless the reduced resistance is equal to, or greater than, that required for new buildings.

16.4 Change of Use of Buildings or Part of a Building

When a change of use results in a structure being reclassified to a Higher Importance Factor (I) as defined in the IS: 1893-2002 "Criteria for Earthquake Resistant Design of Structures (Fifth Revision)", the building shall conform to seismic requirements for a new building with the Higher Importance Factor.

16.5 Structural Safety Provisions during Construction

1. The quality of all materials and workmanship shall conform to accepted standards and Indian Standard Specifications and Codes as included in Part V: Building Materials and Part VII Constructional Practices and Safety, National Building Code of India.
2. All borrow pits dug in the course of construction and repair of buildings, embankments, etc. shall be deep and connected with each other in the formation of a drain directed towards the lowest level and properly stepped for discharge into a river, stream,

channel or drain, and no person shall create any isolated borrow pit which is likely to cause accumulation of water that may breed mosquitoes.

3. Alternative materials, method of design and construction and tests:- The provisions of the regulations are not intended to prevent the use of any material or method of design of construction not specifically prescribed in them provided any such alternative has been approved. Nothing of the provisions of these regulations is intended to prevent the adoption or architectural planning and layout conceived as an integrated development scheme. The competent authority may approve any such alternative if it conforms to the provisions of the relevant parts of the National Building Code, regarding material, design and construction, and the material, method, or work offered is, for the purpose intended, at least equivalent to that prescribed in these regulations in quality, strength, compatibility, effectiveness, fire and water resistance, durability and safety.
4. All buildings shall be constructed on quality control requirements.
5. In case of buildings under construction based on approved development permission, structural safety requirements shall have to be observed. However, due to such structural work of strengthening/retrofitting in the event of natural disaster if certain setbacks and margin get reduced, special permission may be granted by the Competent Authority on case to case basis.

16.6 Structural Safety Tests for Special Buildings

Whenever as per an opinion of panel experts there is insufficient evidence of compliance with the provisions of the regulations or evidence that any material or method of design or construction does not conform to the requirements of the regulations, in order to substantiate claims for alternative materials, design or methods of construction, the competent authority may require tests, sufficiently in advance, as proof of compliance. These tests shall be made by an approved agency at the expense of the owner as follows :

1. Test Methods:- test methods shall be as specified by the regulations for the materials or design or construction in question. if there are no appropriate test methods specified in the regulations, the competent authority shall determine the test procedure. for methods or tests for building materials, reference shall be made to the relevant Indian standards as given in the National Building Code of India published by the Bureau of Indian Standards.
2. Test result to be preserved:- copies of the result of all such tests shall be retained by the Competent Authority for not less than two years after the acceptance of the alternative material
 - a. the testing of the materials as per Indian standards shall be carried out by laboratories approved by the competent authority on this behalf.
 - b. the laboratory/agency shall work out in consultation with the construction agency a testing programme of materials such as cement, steel and quality of concrete including its mixing, laying and strength at site as well as in the laboratory.
 - c. this should cover various stages of construction from foundation to completion as per regulation. The laboratory shall maintain a duly authenticated report in a bound register, copy of which will be submitted to the construction agency, which will in turn forward the testing report to the Competent Authority.

16.7 Design for Structural and Seismic Safety

16.7.1 Design Standards

The structural design of foundations, elements of masonry, timber, plain concrete, reinforced concrete, pre-stressed concrete and structural steel shall conform to:

1. The provisions of the National Building Code of India second revision, Part VI - Structural Design (Section – 1 Loads, Section – 2 Foundation, Section – 3 Wood, Section – 4 Masonry, Section – 5 Concrete and Section – 6 Steel), and as amended from time to time and,
2. The following Indian Standards:

Structural Safety:

1. IS: 456: 2000 “Code of Practice for Plain and Reinforced Concrete”
2. IS: 800: 1984 “Code of Practice for General Construction in Steel”
3. IS 875 (Part 2): 1987 “Design loads (other than earthquake) for buildings and structures” Part 2 Imposed Loads
4. IS 875 (Part 3): 1987 “Design loads (other than earthquake) for buildings and structures”

Part 3 Wind Loads

1. IS: 883: 1966 “Code of Practice for Design of Structural Timber in Building”
2. IS: 1904: 1987 “Code of Practice for Structural Safety of Buildings: Foundation”
3. IS1905: 1987 “Code of Practice for Structural Safety of Buildings: Masonry Walls”

Seismic Safety:

1. IS: 1893-2002 "Criteria for Earthquake Resistant Design of Structures (Fifth Revision)"
2. IS:13920-1993 "Ductile Detailing of Reinforced Concrete Structures subjected to Seismic Forces - Code of Practice"
3. IS:4326-1993 "Earthquake Resistant Design and Construction of Buildings - Code of Practice (Second Revision)"
4. IS:13828-1993 "Improving Earthquake Resistance of Low Strength Masonry Buildings - Guidelines"
5. IS:13827-1993 "Improving Earthquake Resistance of Earthen Buildings - Guidelines"
6. IS:13935-1993 "Repair and Seismic Strengthening of Buildings - Guidelines"
7. "Guidelines for Improving Earthquake Resistance of Buildings", by Expert Group, Government of India, Ministry of Urban Affairs & Employment, published by Building Materials and Technology Promotion Council, 1998.
8. In pursuance of the above, a certificate as indicated in Form 2A shall be submitted along with building plans/ drawings and other building information schedule annexed thereto.

Cyclone/ Wind Storms:

1. IS 875 (3): 1987 "Code of Practice for Design Loads (other than Earthquake) for Buildings and Structures, Part 3, Wind Loads"
2. “Guidelines (based on IS 875 (3): 1987) for Improving the Cyclonic Resistance of Low-rise Houses and Other Building”, by Expert Group, Government of India, Ministry of Urban Affairs & Employment, published by Building Materials and Technology Promotion Council,1998.

Note: Wherever an Indian Standard including those referred to in the National Building Code or the National Building Code is referred, the latest revision of the same shall be

followed except specific criteria, if any, mentioned above against that Code. All Standards applicable as amended from time to time by Competent Authority.

16.7.2 Structural Inspection Report

A Structural Inspection Report (SIR) shall be prepared for all buildings specified in Schedule 6 and submitted as specified in Form No. 15.

16.8 Structural Safety of Display Structures

Every display structure such as billboard shall be designed to ensure safety and be installed in compliance of National Building Code.

17. ENVIRONMENTAL MANAGEMENT

17.1 Minimum Distance from Water body

1. Minimum clearance of 30 mts shall be provided between the boundary of the bank of a river where there is no embankment and any development work or part thereof.
2. Minimum clearances of 15 mts to be provided between the embankment of a river and any building or part thereof or any other clearance as may be prescribed under any other general or specific orders of Government and appropriate Authority whichever is more.
3. Minimum clearances of 9mts shall be provided between the boundary of any other water body such as lake (talav), canal or nala and any building or part thereof.
4. Where a water course passes through a low lying land without any well defined bank, the applicant may be permitted by the Competent Authority to restrict or re-direct the water course to an alignment and cross-section determined by the Competent Authority.

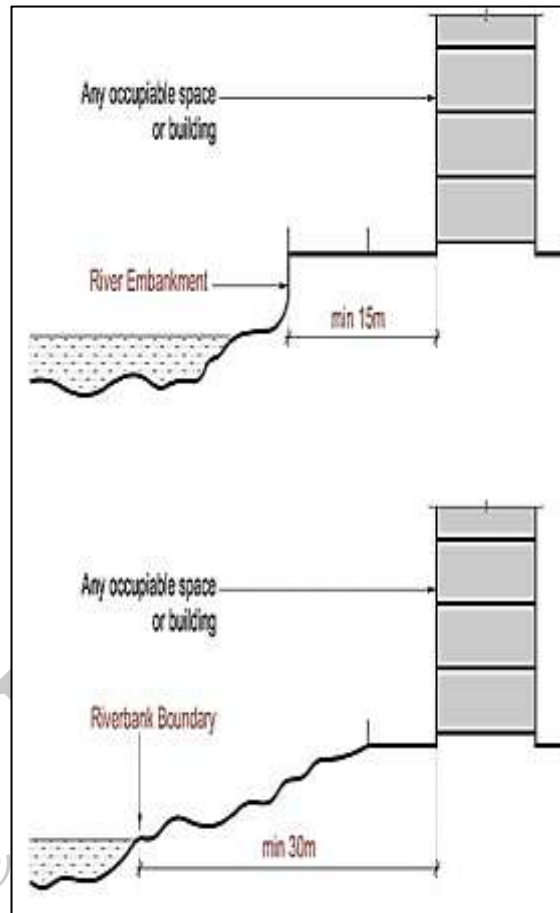

17.2 Rain Water Management

17.2.1 Rain Water Disposal

1. The roof (terrace) of a building and the remaining area of the building-unit shall be provided with an effective rain water drainage system so as to ensure that the rain water is not discharged into adjacent building units and no dampness is caused in any walls or foundation of adjacent buildings.
2. Rain water pipes shall be affixed to the outside of the walls of the building or in recesses or formed in such walls or in such other manner as may be approved by the Competent Authority.
3. No roof or terrace abutting on a public street shall be constructed without providing sufficient number of down take pipes and such pipes shall be so fixed as to discharge the rain water at a level not higher than 0.6 meter above the street level.
4. The manner of channeling rain water discharge from a building-unit to a public storm water drain, if available, shall be determined by the Competent Authority.

17.2.2 Rain Water Harvesting

A water storage tank shall be dug on marginal open Space of building so that rain water drains into the tank, and a tap at appropriate place shall be inserted for extraction of water from the tank and circulation of air. Stored water in the tank shall be used for household use such as washing clothes, floor sweeping and gardening.

Rain water harvesting is mandatory for all buildings with ground coverage 80 sq.mt and above. The system of storm water drainage and storage in reservoirs and recharge should conform to one of the following specifications:

- a. For Buildings with ground coverage above 80 sq.mt and up to 500 sq.mt:

Percolation pit or bore recharge shall be provided in the marginal space around the building. Such pits shall be filled with small pebbles, brick jelly or river sand and covered with perforated concrete slabs as illustrated below:

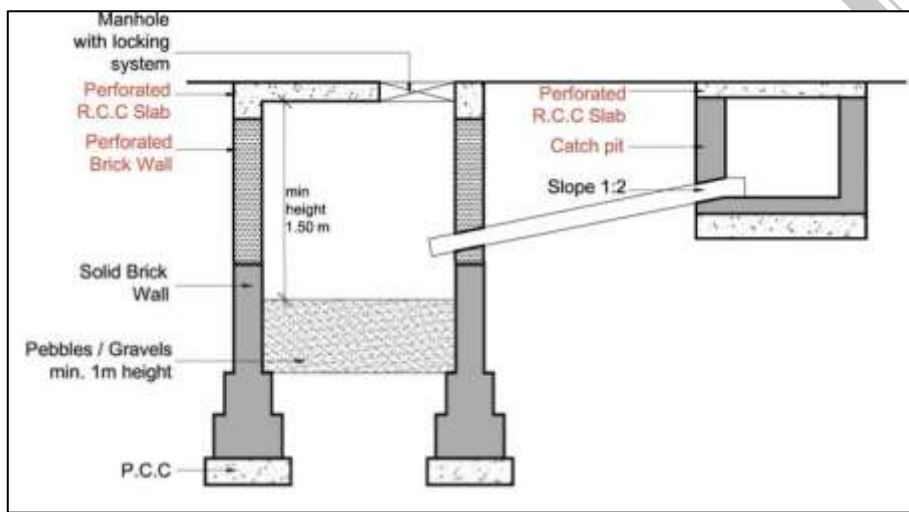

- b. For Buildings with building-unit area above 500sq.mt and up to 1500 sq.mt: Percolating Well with Rain Water Harvesting System shall be provided as illustrated below (up to ground first river):

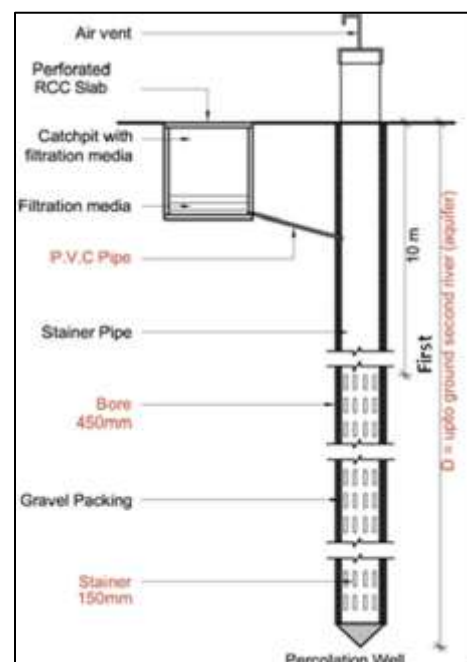
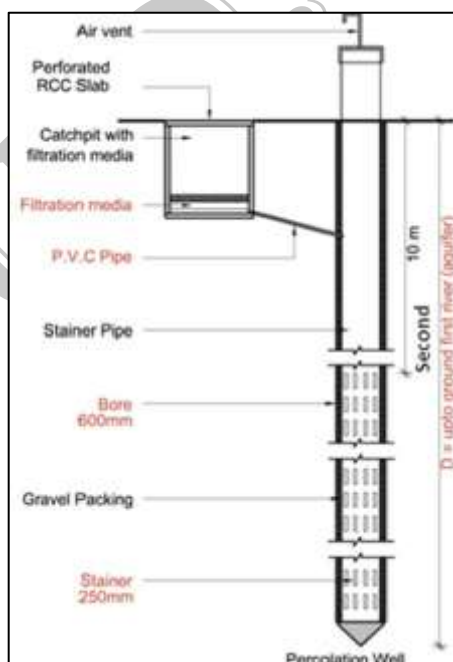

- c. For Buildings with building-unit area above 1500 sq.mt and up to 4000 sq.mt:

Percolating Well with Rain Water Harvesting System shall be provided for every 4000sq.mt as illustrated above (up to ground second river).

- d. For Buildings with building-unit area above 4000 sq.mt:

One Percolating Well shall be provided as per Regulation 17.2.2(c) for every 4000 sq.mt land area. As an alternative to providing multiple percolating wells, a Water Retention Pond with minimum capacity of 300,000 liters with a percolating well for every five percolating wells or part thereof shall be permitted as an alternative.

17.2.3 Rain Water Storage:

For all building-units with area more than 1000 sq.mt, Rain water storage tank shall be mandatory with adequate storage capacity.

17.2.3.1 Solid Waste Management

All buildings shall provide facilities for solid waste management with segregation of dry and wet waste at source. Standards and specifications of facilities shall conform to the following requirements:

17.2.4 Solid Waste Bin for Residential Use

1. Community bin shall be provided in the road-side marginal open space.
2. The size of the bin container shall be calculated at the rate of 10 liters capacity per dwelling unit with a maximum size of bin of 80 liters. The numbers of bins shall be calculated on the basis of total no. of dwelling units/tenements.

17.2.5 Solid Waste Bin for Non-Residential Use

1. Community bin shall be provided in the road-side marginal open space.
2. The size of the bin container shall be calculated at the rate of 20 liters capacity per 100sq.mt of floor area with a maximum size of bin of 80 liters.
3. The bin shall be provided with an air-tight lid.
4. For Hospitals, Hotels and Restaurants- disposal of solid waste shall be carried out as per the norms decided by the Competent Authority from time to time.
5. For Clubs, Community Halls and Party Plots- garbage container shall be provided with a minimum capacity of 4 tones. Such a container shall be placed along a paved area abutting the road of minimum dimensions of 6mt by 7.5 mt. For such a place, used according to provision of this regulation, Competent Authority can collect security deposit from the plot owner as may be decided time to time.

17.3 Grey water Recycling

17.3.1 Applicability

Any owner applying for approval for construction of a new set of buildings of category and total built-up area mentioned below shall make provision for reuse of recycled water:

For waste water of premises of 100 dwelling units a storage tank shall be dug as per proposal of Authority in marginal open space of building and on that tank a sewerage treatment plant shall be installed so that treated water can be used in gardening and plantation.

Table 17.1 Reuse of recycled water

No.	Building Use	Built-up Area (sq.mt)
(1)	(2)	(3)
1	Hospitals and Nursing Homes	More than 5,000
2	Hospitality: Hotels, Lodges, Guest houses	
3	Hostels for Schools, Colleges, Training Centres	More than 10,000
4	Community Centre, Banquet Halls, and similar uses	
5	Commercial	
6	All hazardous, water-polluting, chemical industries	

17.3.2 Note: In every water closet or toilet it shall be mandatory to provide double button cistern (dual Flush tank)

17.3.3 Provisions of Recycling System

The applicant shall along with his application submit the designs, plans, calculations and the references used for the calculations etc to provide the system to recycle the grey water. Such system shall include the provisions to facilitate the following:

1. Treated grey water is pumped to a separate tank on the roof from where grey water will be supplied to water closets, garden taps, car washing taps etc.
2. Only water from water closets should be let in to sewerage system. In every water closet or toilet it shall be mandatory to provide double button cistern (dual flush tank).
3. Wherever arrangements from reuse of recycled water is provided additional arrangements for carrying the excess grey water to the sewerage system may also be provided.
4. In a nature or manner or in a way that shall not constitute a nuisance of foul gases or cause a public hazard or otherwise in compliance of these regulations.
5. The recycled water shall be used for non potable, no contact purposes within premises and shall not be connected to sewage/waste water system of local authority. However the waste generated by the recycle plant can be connected to local authority sewer network if it is of the accepted quality as mentioned in Competent Authority GDCR.
6. Separation of grey water:
 - a. The wastes from toilets in the premises will be separated from grey water that is of bathroom and kitchen wastes by means of separate down take discharge system.
 - b. The grey water shall be recycled by providing recycling plant and shall be reused for non potable purposes after storing the same in distinctly separate tank by means of purple colored down take pipes.
 - c. The water quality shall conform to standards of non-potable water. The recycled water shall be tested once in six months and results shall be made available to Competent Authority whenever demanded.
 - d. The make-up connection to the system will be done at the collection tank of the treated water, through a free fall if from Municipal water connection.
7. Separate plumbing for grey water:
 - a. Every developer/owner shall provide the newly constructed building with the provision of down take plumbing for grey water, recycling water plant, storage and reuse fitting before selling the building.
8. Reuse of water strictly for non-potable non-contact use.
 - a. The reuse of water will be strictly for non-potable use by means of providing a distinctly separate reuse system coloured in purple. The non-contact uses shall be

restricted to toilet flushing, drip irrigation of trees/shrubs, sub surface irrigation of lawns and recharge of ground water.

- b. There shall not be cross-connection of fitting of the potable and non-potable water at any point. The recycled water system shall be maintained at a lower operating pressure than that of the potable water system. Precautions should be taken to prevent cross contamination.

17.3.4 Quality of Water and Treatment

1. The water generated after treatment should be safe for its use for flushing toilets, gardening etc.
2. The company or the agency engaged for installation of system for recycling of waste water shall preferably confirm ISO:14000.
3. Provision may be made for checking the quality of recycled water with Water testing laboratory with Municipal Corporation or Water Supply and Sewerage Board.
4. The testing of wastes and the submission of the results shall be done in a manner in accordance with the terms and conditions prescribed by the Municipal Commissioner or Gujarat Pollution Control Board (GPCB) / Competent authority.

17.3.5 General Provisions

1. Mandatory disclosure: regarding changes: An occupier of premises shall inform the competent authority of any change in the quality, nature or quantity of the wastes discharged from his plant or premises the manner of their discharge of water immediately if the change is likely to cause discharge of water in violation of license under these regulations.
2. Corrective action: In the event it is found any person violating the provisions of these regulations, the Competent Authority or Gujarat Pollution Control Board shall issue notice and after inquiry and personal hearing take necessary corrective action.
3. Dispute Resolution All the disputes arising in the enforcement of this by these rules shall be referred to Municipal Commissioner who in turn will resolve the disputes in advise with his authorized technical officer or any experts and intimate to the occupier / owner / developer. The decision of the Municipal Commissioner will be final and binding on the occupier.
4. List of Authorized Laboratories shall be as authorised by Gujarat State Pollution Control board or the Municipal corporation
5. Characteristics of effluent water quality from the Grey Water Recycling plants shall be as approved by the Gujarat Pollution Control Board.

17.3.6 Enforcement of Regulations

1. In case of proposed/intending /under redevelopment properties, the occupier/ developer/ owner will submit an application to the competent authority with details of proposed 'grey water reuse system ' along with the application for demand of water permission to connect the Grey Water/sewage to municipal sewage system.
2. Conditional Waste Discharge Permission waste discharges of the conditional type plant will be allowed on the issue of a conditional permission provided the conditional type plant has recycling and reuse of water facility and not exceeding limits given in as per GPCB norms.

17.4 Tree Plantation

1. All buildings shall provide tree plantations conforming to the following:

2. Building unit having area of more than 100 sq.mt shall be provided with minimum four trees and further for every 200sq.mt area or part thereof and upto 500sq.mt. of area minimum four trees, and beyond that for every 200sq.mt area or part thereof minimum five trees shall be provided.
3. The trees shall preferably be shade-giving and from the species listed in Schedule 12.
4. The requirement of trees shall be reduced on the basis of the number of grown existing trees that are conserved and not affected by the proposed development.
5. Trees shall be planted on site and guarded by the tree guards and shall be maintained Properly.
6. Trees shall be planted without causing obstruction to the easy movement of fire fighting vehicles in case of fire emergency.
7. A person applying for permission to carry out any development shall have to pay tree plantation deposit along with his application to the Competent Authority at the rates decided by the Competent Authority time to time. This deposit shall be refundable after the period of five years with the condition that trees planted on the site shall be grown-up and maintained properly, otherwise the deposit shall be forfeited and shall be utilised only for tree plantation and maintenance by the Competent Authority.
8. Competent Authority may consult Forest and Environment Department for tree typology, plantation and maintenance, etc. if required.

17.5 Solar Water Heating System

All buildings in the following categories of buildings shall provide solar-assisted water heating system:

Table 17.2: Building use & built-up area

No.	Building Use	Built-up Area
(1)	(2)	(3)
1	Bedded Hospitals and Nursing Homes	Irrespective to built up area.
2	Hospitality: Hotels, Lodges, Guest houses	More than 2,000 sq.mt
3	Hostels for Schools, Colleges, Training Centers	
4	Community Centre, Banquet Halls, and similar uses	
5	Residential – detached and semi-detached dwelling units	More than 200 sq.mt of individual dwelling unit area

17.5.1 Roof Top Solar Energy Installations and Generation

Table 17.3: Norms for Roof Top Solar PV Installation and generation

Sr. No.	Category of buildings/area	Area standards	Generation requirement *
(1)	(2)	(4)	(5)
Residential			
1	Plotted Housing	Greater than 1000 Sq mt	Minimum 5% of connected load or 20W/sqft for “available roof space”**, whichever is less.
2	Group Housing	All proposals, as per Group Housing Norms	Minimum 5% of connected load or 20W/sqft for “available roof space”, whichever is less.
	All other buildings (Government or Private) (mandatory for buildings having shadow free rooftop area > 50 sqmt)		

Sr. No.	Category of buildings/area	Area standards	Generation requirement *
(1)	(2)	(4)	(5)
3	Educational Institutional Commercial Industrial Mercantile Recreational	Plot size of 1000 sqmt and above	Minimum 5% of connected load or 20W/sqft for “available roof space”, whichever is less.

* Area provisions on roof top shall be @12 sq.mt per 1KWp, as suggested by Ministry of New and Renewable Energy.

** “available rood area” = 70 % of the total roof size, considering 30 % area reserved for residents’ amenities.

17.6 Energy Efficient Buildings

Any owner or developer, construct an Energy Efficient Buildings and produce a certificate from GRIHA (Green Rating for Integrated Habitat Assessment) or any other Government recognised Institute, showing the rating for the building, According to that rating certificate, The Competent Authority shall offer some incentives in the rate of chargeable FSI for the energy efficient buildings (Green Building) as 5% discount in the total payable amount.

Owner shall have to apply prior to commencement of the project to GRIHA for the rating certificate and registration.

17.7 Environment Impact Assessment

1. No development permission shall be given to the Building and Construction projects, Townships and Area Development project having built up area mention in the table below, until getting Environment Clearance from SEIAA (State Level Environment Impact Assessment Authority) as required under the Environmental Impact Assessment notification-2006 and amended from time to time.

No.	Project or Activity	Area	Remark
1	Building and Construction projects	Having Built-up area 20,000 sq.mt or more and less than 1,50,000 sq.mt.	Built-up area is for covered construction; in the case of facilities provided open-to- sky, then activity area shall be considered
2	Townships and Area Development project.	Having area of building-unit 50 Ha. or more OR Having built up area 1,50,000 sq.mt or more	

2. Any Building and Construction projects, Townships and Area Development project falling under the category as mention in the table in 2. above and if the developer split the project into phases, developer has to produce Environment Clearance from SEIAA, as required under the Environmental Impact Assessment notification - 2006, prior to the approval of first phase of the project.

18. POLLUTION CONTROL

18.1 Air Pollution

All buildings shall conform to provisions of Air Pollution Control Act, 1981 and to the provisions of Gujarat Smoke Nuisance Act, 1963 and amended from time to time.

18.2 Water Pollution

All buildings shall conform to provisions of Water (Prevention and Control of Pollution) Act, 1974.

18.3 Noise Pollution

All buildings shall maintain ambient air quality standards in respect of noise, as prescribed in the Noise Pollution (Regulation and Control) Rules, 2000.

18.4 Industrial Pollution

No industrial effluent shall be disposed or exposed so as to cause nuisance and endanger to public health and shall not be disposed in a water body of any kind.

Without prejudice to the generality of the above provisions, the Competent Authority may stipulate certain conditions or measures to control the air borne emissions and liquid effluents from industrial units. These measures shall be stipulated as conditions of the building permission.

Industries in the special industrial zone which emit liquid and gaseous effluents shall not be allowed to emit such effluent unless they are purified and rendered harmless from the public health point of view by provision of purification plants, as may be prescribed by the Competent Authority and/or the Gujarat Pollution Control Board.

19. MAINTENANCE AND UPGRADATION

19.1 Maintenance of Buildings

19.1.1 Responsibility for Maintenance of Buildings

It shall be the responsibility of the Owner of a building to ensure that the building is kept in good repair, such that its structural stability is not compromised.

For the purpose of this regulation, buildings will be classified in two categories:

Class 1: All types of framed structures, factory buildings, cinema, auditorium and other public institutional buildings, schools and college buildings, hostels.

Class 2: Masonry-walled residential buildings constructed with height more than 9.0 mts.

19.1.2 Periodic Inspection and Maintenance Certificate

All buildings in Class 1 and Class 2 shall require periodic inspection by a SEOR at intervals specified in Schedule 6. The SEOR shall inspect the building to ascertain and certify to the Competent Authority, that the building's structural stability has not been compromised due to lack of adequate maintenance along with a Structural Inspection Report. It shall be the responsibility of the Owner to submit the certificate to the Competent Authority no later than one month after the date on which inspection is due.

19.2 Maintenance of Lifts and Escalators

19.2.1 Responsibility for Maintenance of Lifts and Escalators

It shall be the responsibility of the Owner of a building to ensure that lifts and escalators in the building are kept in good repair, such that their use is safe.

19.2.2 Maintenance Protocol

1. Maintenance protocol for lifts and escalators shall be as per following Indian Standards amended from time to time.:
 - a. IS: 1860 – 1980 Code of Practice for Installation, Operation and Maintenance of Electric Passenger and Goods Lift;
 - b. IS: 6620 – 1972 Code of Practice for Installation, Operation and Maintenance of Electric Service Lifts; and
 - c. IS: 4591 – 1968 Code of Practice for Installation and Maintenance of Escalators.
2. The lift installation should receive regular cleaning, lubrication adjustment and adequate servicing by authorised competent persons at such intervals as the type of equipment and frequency of service demand.
3. In order that the lift installation is maintained at all times in a safe condition, a proper maintenance schedule shall be drawn up in consultation with the lift manufacturer and rigidly followed.
4. A log book to record all items relating to general servicing and inspection shall be maintained.
5. The electrical circuit diagram of the lift with the sequence of operation of different components and parts shall be kept readily available for reference by persons responsible for the maintenance and replacement, where necessary, to the satisfaction of the Competent Authority.
6. Any accident arising out of operation of maintenance of the lifts shall be duly reported to the Competent Authority.

19.3 Maintenance of Fire Prevention and Safety Provisions

It shall be the responsibility of the Owner of a building to ensure that all the fire prevention and safety provisions in a building are kept in good working condition at all times.

The fire prevention and safety provisions shall include all the fixed fire protection systems, installations, fire extinguishers, first aid kits, fire lifts and escape stairs provided in the building.

19.3.1 Periodic Inspection and Maintenance Certificate

For all buildings with height more than 13 mts, the Fire Protection Consultant on Record shall inspect the building at intervals not more than 12 months to ascertain and certify to the Competent Authority that the building's fire safety has not been compromised due to lack of adequate maintenance.

20. CONFORMITY TO OTHER ACTS AND REGULATIONS

20.1 Minimum Clearances from Trunk Infrastructure

The margins from the Building-unit boundary are as sanctioned GDCR of competent authority. Following clearances are to be observed, as applicable.

20.1.1 Minimum Clearances from Electrical Lines

For Building-units in the vicinity of Electrical Lines, clearances shall be provided between any building or part thereof and electrical lines according to the following table and illustrated below:

Table 20.1: minimum clearances from Electric lines

Sr. No. (1)	KV of Electrical Line (2)	Minimum Clearance from Centre of Electrical Grid Line (3)
1	220	17.5 mts
2	132	13.5 mts
3	110	11.0 mts
4	66	9.0 mts
5	33	7.5 mts
6	22	3.0 mts
7	11	2.5 mts

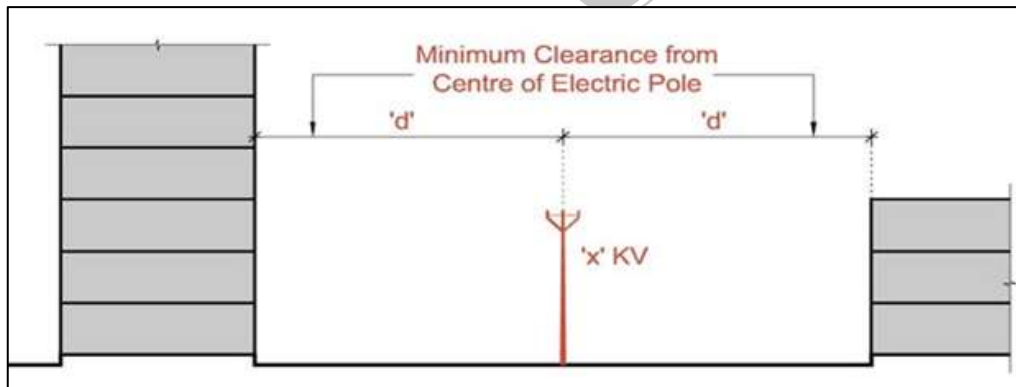

20.1.2 Minimum Clearances from Petroleum Pipelines

Minimum Clearances to be provided between any building or part thereof and petroleum pipelines shall be 12mts from the centre of pipeline.

20.1.3 Minimum Clearances from Oil Well

Clearances to be provided between any building or part thereof and oil well shall be in accordance with provisions of the Oil Mines Regulations - 1984, under the Mines Act, 1952, in addition to these regulations.

20.1.4 Minimum Clearances from Water Body

Minimum clearance shall be provided as per Performance Regulation 17.1

20.2 No Objection Certificates (NOC)

Development Permission granted by Competent Authority on the basis of any document/NOC received is not final and conclusive. It shall be considered in true sense and meaning of concerned issuing Authority. This Authority has no legal responsibility for such development permission.

20.2.1 NOC from Airport Authority

For Building-units within Airport Funnel Area and Critical Area ,construction for Building regulated as per NOC shall be required from the Airport Authority.

20.2.2 NOC from Railway

For Building-unit within 30mts vicinity of Railway Boundary, NOC to be provided from the Railway Authorities and as amended from time to time.

20.2.3 NOC from Commissioner of Police

For Building-units with uses for Assembly, Religious, Hospitality, Party Plot and Fuelling & eV Stations shall require an NOC from the Commissioner of Police.

20.2.4 NOC from Jail Authority

For Building-units within 300mts vicinity of any Jail, an NOC shall be required from the Jail Authority.

20.2.5 NOC from ISRO

Development in the vicinity of ISRO shall be regulated and controlled in accordance with provisions of ISRO.

20.2.6 NOC from ASI

Development in the vicinity of protected monuments shall be regulated and controlled in accordance with provisions of Archeological Survey of India.

20.2.7 NOC from Defence Establishment

Development in the vicinity of defence establishments, shall be subject to N.O.C from Station Commander. Explosives Rules 1983 under Indian Explosives Act 1884.

20.2.8 Environmental Clearance

Notification of Requirement of Environmental Clearance of Projects, 1994 (MOEF), Environment Protection Act 1986 and Environment Protection Rules 1986.

20.2.9 NOC under Urban Land Ceiling Act

In case of land considered within the Urban Land Ceiling (U.L.C.) Act, 1976 Limit, the applicant shall submit along with application:

- i. The N.O.C. from the Competent Authority under the U.L.C. Act, 1976
- ii. An affidavit and indemnity bond in the prescribed form under the U.L.C. Act, 1976.

20.3 Conformity to other Acts

20.3.1 Factories Act 1948 and Factories Rules under the Govt. of Gujarat

20.3.2 Gas Cylinders Rules 1981

20.3.3 Explosives Rules 1983 under Indian Explosives Act 1884

20.3.4 Manufacture, Storage and Import of Hazardous Chemicals Rules 1989

U.D. & U.H.D.

21. Quality Control and Inspection.

21.1 Applicability

The Quality Control and Inspection shall apply to all Residential buildings, which are more than 16.50 Meter height and all non-residential building as well as all type of building falling in seismic Zone IV & V.

21.2 Inspection and Safety Certificate:

1. The Owner/ developer/ occupants and registered appointed Person on Record shall have to certify the inspection and safety report as per Schedule No.17.
